

S E R V I C E

M A N U A L

36V MODELS



E-Bike[®]
Service Manual
36V MODELS

EV Global Motors Company
16201 Stagg Street
Van Nuys, CA 91406

Tel: 818/756-0566
Fax: 818/756-0563
www.ebike.com

Copyright © 2000 EV Global Motors Company

First Edition
October, 2000
LIT-82001-01-36

All rights reserved. No parts of this publication may be reproduced or transmitted in any form or by any means without the prior permission of EV Global Motors Company.

Although every precaution has been taken to assure this publication is complete and accurate, EV Global assumes no liability for errors or omissions. All information contained in this publication is based on the latest information available at the time of publication and is subject to change without notice.

TABLE OF CONTENTS

Chapter One: General Information	1-1
Beep/LED Codes	
Vehicle Identification Number	
How to Read the Model Code	
Terms	
Lubricants	
Threadlock	
Recommended Maintenance Schedule	
Special Tools	
Chapter Two: Specifications	2-1
Mechanical Specifications	
Gear Ratios	
Electrical Specifications	
Torque Specifications	
Performance Specifications	
Frame Specifications	
Chapter Three: Battery Pack	3-1
Charging the Battery	
Replacing the Battery	
Replacing the Charger	
Battery Pack Test	
Chapter Four: Handlebar and Controls	4-1
Handlebar Position	
Handlebar Height Adjustment	
Handlebar Replacement	
Throttle Control (Right Side)	
Accessory Control (Left Side)	
Headset	
Chapter Five: Brakes	5-1
Brake Cable Replacement	
Brake Lever	
Brake Lever Free Play Adjustment	
Brake Pad	
Brake Pad Alignment	
Caliper Arm	
Modulator Brakes	
Disc Brake	
Chapter Six: Shifter and Derailleur	6-1
Shifter	
Shifter Cable	
Derailleur	
Chapter Seven: Chain and Crankset	7-1
Chain	
Crank Arm	
Chainring	
Pedal	
Bottom-Bracket Cartridge	
Chapter Eight: Electrical	8-1
Connector Identification	
Right Side Cover	
Left Side Cover	
Controller	
Quick-Release Connector	
Motor	
Headlight	
Taillight	
Troubleshooting	
Electrical Schematic	

Chapter One

GENERAL INFORMATION

BEEP/LED CODES

The three state-of-charge LEDs on the throttle control indicate battery state of charge. The E-Bike® uses these LEDs and three distinct beeps to alert you to particular conditions. The following chart describes these signals and their various meanings.

Code	Meaning	Beep	LEDs
Good beep	The system has been checked and is operational	1 continuous beep sounds for 1 second.	
Bad Beep	A problem exists in a system or component.	4 sets of 4 short beeps	
Pedal assist	The system requests pedal assist. Sounds when on a steep hill or when the motor or controller approaches an overheat condition.	3 short beeps every 16 seconds	
System ON	Whenever the power knob is turned ON, the system performs a series of checks. This signal indicates that the E-Bike® is ON and ready for operation.	Good beep	The state-of-charge LEDs flashes
Throttle Fault	This code occurs whenever you turn the power knob ON while pressing the throttle or if the throttle is faulty. Turn the power OFF, release the throttle, and turn the power knob to ON. If the code persists, have throttle checked by an authorized E-Bike® dealer.	Bad beep	All 3 state-of-charge LEDs flash continuously until the fault is cleared and until the power knob is turned OFF then ON again.
Battery state-of-charge	The battery has 100% to 80% of run time remaining.	None	Green LED on.

Code	Meaning	Beep	LEDs
Battery state-of-charge	80% to 60% of run time remaining	None	Green and yellow LEDs on.
	60% to 40% of run time remaining.	None	Yellow LED on.
	40% to 15% of run time remaining.	None	Yellow and red LEDs on.
Low battery	15% to 5% of run time remaining.	None	Red LED on.
Very low battery	Less than 5% of run operation remaining.	Bad beep	Red LED flashes
Motor shut off	The power to the motor has been shut off. You must pedal	Bad beep	Red LED flashes
Overheat condition	The motor or controller temperature exceeds operating temperature. The controller cuts power to the motor. You must pedal until the temperature drops to operating temperature.	Bad beep	Yellow LED flashes
Operating temperature	The motor has cooled to operating temperature. You may resume using the throttle.	Good beep	The appropriate LED turns on
Overheat and low-battery condition	The motor temperature exceeds operating temperature and the battery state-of-charge is low.	Bad beep	The yellow and red LEDs flash simultaneously.

VEHICLE IDENTIFICATION NUMBER

The 17-digit vehicle identification number (VIN) is printed on a label that is affixed to the inside face of the right frame seat stay. This label also contains the gross-vehicle weight rating and recommended tire inflation pressure.

HOW TO READ THE MODEL CODE

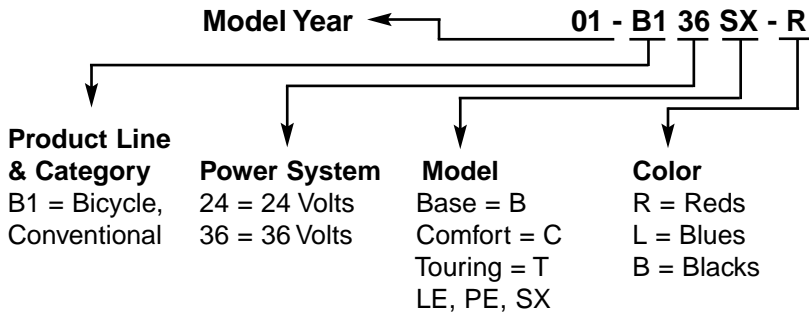

Model code	Model prefix	Year	Description	Color 1	Color 2	Color 3
B1 Bicycles						
01-B136LE – R, L	3B1	2001	LE	Candy Apply Red (R)	Radiant Metallic Blue	NA
01-B136SX – B	3B1	2001	SX	Satin Black (B)	NA	NA
01-B136PE – B	3B1	2001	PE	Black (B)	NA	NA

TERMS

Left and Right

Most of the time, left and right in this manual refer to the rider's point of view when seated on the E-Bike® and facing forward. The one exception to this rule involves the brake calipers. Left and right on the calipers refers to a technician's point of view when standing in front of the E-Bike® and looking directly at the front brake caliper or when standing behind the E-Bike® and looking directly at the rear brake caliper.

NOTE, CAUTION and WARNING

The terms NOTE, CAUTION and WARNING have specific meaning in this manual. A NOTE provides additional information to make a procedure easier or clearer.

A CAUTION emphasizes precautions that must be taken to avoid damage to your tools or to the E-Bike®.

A WARNING alerts you to a situation where negligence could lead to injury or death. Take WARNINGS seriously. Failure to heed a WARNING could result in serious personal injury or death.

LUBRICANTS

Grease

The bearings and other mechanical components in the E-Bike® operate at relatively low temperatures so most automotive greases are inappropriate for use on the E-Bike®. Always use grease made specifically for a bicycle, such as grease from Bullshot, Campagnolo, Finish Line, Pedros, Phil Wood, and Shimano.

Oil

Always use oils made specifically for bicycle use. Bicycle oils need to be thin enough to penetrate tight places, they should be durable so they can withstand exposure to the elements, and they must resist the accumulation of dirt.

Suitable oils for the E-Bike® include Alsop, Bullshot, Campagnolo, Finish Line, Lube Wax, Phil Wood Tenacious Oil, Pedros, Superlube, and Triflow.

Motor oil, WD40, 3-in-1 Oil, sewing machine oil, gun oil, and other common oils are not suitable and should not be used.

In general, applying oil from a drip applicator is superior to using aerosols. Aerosols promote over-lubrication, which leads to excessive accumulation of dirt. Apply oil sparingly. Apply enough oil to do the job, but not so much that it starts to drip from the component. After applying any oil, wipe off the excess.

THREADLOCK

A threadlocking compound should be used on most fasteners on the E-Bike®. Threadlocking compound prevents loosening caused by vibration and helps seal out moisture.

Loctite 242 (blue) or equivalent is recommended for threadlocking applications. Loctite 242 is a medium-strength threadlocking compound that permits disassembly with common hand tools.

Before applying Loctite to threads, clean the thread surface of oil, grease, and other residue. Apply a small amount of Loctite. Excess compound could work its way down the threads and bond parts together. The torque chart in Chapter Two includes Loctite recommendations for particular fasteners.

RECOMMENDED MAINTENANCE SCHEDULE

Component or Condition	Inspect before every ride	Inspect every 5 to 10 rides*
Brake pad adjustment	X	
Wheel quick release adjustment	X	
Tire pressure	X	
Tire wear/damage	X	
Head/tail/brake light operation	X	
Mirror position	X	
Controls and display	X	
Seatpost quick release adjustment	X	
Brake pad wear		X
Brake cable tension/wear	X	X
Spoke tension		X
Wheel true		X
Hub bearings adjustment		X
Hub bearing lubrication		X
Chain lubrication		X
Derailleur adjustment		X
Reflectors		X
Battery and charger		X
Headset adjustment		X
Bottom bracket adjustment		X
Tighten all bolts, nuts, and mounting hardware		X

* Depending upon length of ride and riding conditions. Inspect more frequently when riding in dusty or wet conditions.

SPECIAL TOOLS

The following special tools are needed for servicing the E-Bike®.

Tool	Part number
Hex wrench set: 4mm, 5mm, 6mm	Park AWS-1
Hex wrench set	Park AWS-11C
Hex wrench set: 2mm, 5mm, 3mm	Park AWS-3
Fourth hand cable stretcher	Park BT-2
Chain checker	Park CC-2C
Chain breaker (screw type)	Park CT-3
Crank wrench	Park CCW-14R
Cable and housing cutter	Park CN-4C
Gearclean brush	Park GSC-1
32mm & 36mm head wrench	Park HCW-15
Pedal wrench	Park PW-3
Spoke wrench (black)	Park SW-0
Spoke wrench (red)	Park SW-2
Tire lever set	Park TL-1C
Freewheel tool	Park Tool FR-1
Bottom-bracket-cartridge tool	Park Tool BBT-2

Chapter Two

SPECIFICATIONS

Table 1: Mechanical Specifications

Component	Specification
Headset	
Stack height	33 mm (1.30 in.)
Dimensions	25.4 mm x 34 mm x 30 mm w/seal
Forks (LE)	
Type	Polyurethane Allen key adjustable
Steerer tube	1-1/8 in.
Travel	65 mm
Triple Forks (SX/PE)	
Type	Nitro DH
Steerer tube	1-1/8 in.
Travel	75 mm
Stem 1	
PE model	17 degrees, 110 mm extension
SX model	15 degrees, 110 mm extension
LE model	40 degrees, 110 mm extension
Stem 2	28.6 mm x 25.4 mm x 150 mm with quill
Handlebar	
LE model	
Rise	9 degrees
Width	625 mm
Handle	200 mm
Center flat	100 mm
SX/PE models	
Rise	9 degrees
Width	660 mm
Handle	200 mm
Center flat	100 mm
Seatpost	
LE model	300 mm x 30.0 mm O.D.
Seatpost spacer	100 mm x 30.1 mm ID x 34.9 mm O.D.
Seatpost, suspension	
SX/PE models	350 mm x 27.2 mm O.D.
Seatpost spacer	100 mm x 27.3 I.D. x 34.9 mm O.D.
Tires	
LE model	26 x 1.95 in., black w/ reflective stripe, puncture resistant

SX model	26 x 1.95 in., CSK, puncture resistant
PE model	26 x 1.95 in., black with reflective stripe, puncture resistant
Rims	
DH-17	
Front	26 x 1.5 in., 14G x 32H, double wall
Rear	26 x 1.5 in., 14G x 36H, double wall
G3000	
Front	26 x 1.5 in., 14G x 32H, double wall
Rear	26 x 1.5 in., 14G x 36H, double wall
Spokes, front	
DH-17 rim	266 mm, 14G stainless with brass nipples
G3000 rim	254 mm left, 255 mm right, 14G stainless with brass nipples
Spokes, rear	
DH-17 rim	216 mm left, 216 mm right, 14G stainless with brass nipples
G3000 rim	210 mm left, 209 mm right 14G 14G stainless with brass nipples
Bottom bracket (B/B)	127 mm cartridge
Freewheel	14-28 T, 7-speed
Chainring	38 T
Chainring clearance	16~17 mm (0.63~0.67 in.)
Crankarm	170 mm (6.7 in.)
Chain	1/2 x 3/32 x 110 L

Table 2: Gear Ratios

Chainring	Freewheel	Gear Inches	Ratio
38T	14T	70.6	0.37 (14/38)
38T	16T	61.8	0.42 (16/38)
38T	18T	54.9	0.47 (18/38)
38T	20T	49.4	0.53 (20/38)
38T	22T	44.9	0.58 (22/38)
38T	24T	41.2	0.63 (24/38)
38T	28T	35.3	0.74 (28/38)

Table 3: Electrical Specifications

Component	Specification
Battery (WP8-36E)	Single block
Type	Deep discharge, sealed AGM lead-acid
Capacity	36 volts, 8 amp hours.
Charger	
Input	115 VAC, 60/50 Hz, 1 amp
Output	36 VDC, 2 amps
Charger cord	
Length	1.8 m (6 ft.)
Wire	18 AWG, 2-wire with ground

Table 4: Torque Specifications

Item	kg-cm	in.-lb.	ft.-lb.	Special Instructions
Handlebar-binder bolt	140~200	-	10~15	Apply Loctite
Handlebar-arm clamp bolts	140~200	-	10~15	Apply Loctite
Stem-binder bolt (stem-2 quill bolt)	180~250	-	13~18	
Headset locknut	40~50	34.7~43.4		
Accessory control clamp bolt	30~40	26.5~34.7	-	
Throttle control clamp bolt	30~40	26.5~34.7	-	
Controller mounting screw	15	13.0	-	
Brake-lever clamp bolt	30~40	26.5~34.7	-	
Brake-caliper pinch bolt	140~200	-	10~15	Apply Loctite
Brake-pad nut	63.6~85.2	53~71	-	
Caliper pivot bolt	85.2~106.8	71~89	-	Apply Loctite
Left-side-cover mounting screws	10	8.6	-	Apply Loctite
Right-side-cover mounting screws	10	8.6	-	Apply Loctite
Battery-terminal-block mounting screw	10	8.3	-	
Battery compartment mounting screw	10	8.3	-	
Battery pack handle	15	13.0	-	
Battery cover screw	20~30	17.4~26.5		Apply Loctite
Charger-board mounting screw	10	8.6	-	
Derailleur mounting bolt	84	70	-	
Derailleur pinch-mechanism nut	42	36.5	-	
Shifter clamp bolt	30~40	26.5~34.7	-	
Mirror-mounting screw	30~40	26.5~34.7	-	
Chain guard screws	15	13.0	-	Apply Loctite
Left bottom-bracket cover screws	20~30	17.4~26.5	-	Apply Loctite
Crank-arm mounting bolt	200~250	-	14.4~18.1	Apply grease to the bolt threads
Pedal	30~50	26.5~43.4	-	Apply grease to the stud threads
Bottom-bracket cartridge adapter ring	300~400	-	21.7~28.9	Apply grease to the threads
Chainring bolt	350~450	-	25~32	Apply oil to the bolt threads
Motor torque arm	15	13.0	-	Apply Loctite
Headlight mount	15	13.0	-	
Taillight mounting nut	20	17.4		
Horn mounting nut	15	13.0	-	
Cord access cover	5	4.2	-	
Frame mounted connector	10	8.6	-	Apply Loctite
Front fender	15	13.0	-	
Rear fender	15	13.0	-	
Front fork clamp bolt				
Triple Fork (SX/PE)	100	89	-	
Forks (LE)	100	89	-	
Fork slider bottom bolt				
Triple Fork (SX/PE)	70	62	-	
Forks (LE)	70	62	-	

Table 5: Performance Specifications*

Item	Specification
Top speed	17.5 mph @ 36 volts in "P" Performance mode. 12.5 mph @ 36 volts in "E" Economy mode.
Maximum grade	Over 12% with a 200 lb. rider plus load.
Acceleration	0~10 mph in 3 seconds with a 200 lb. rider.
Range	Over 20 miles with moderate pedal assist. Over 15 miles with no pedaling under good conditions. Over a 25% increase in the range in the "E" Economy mode

*200-pound rider with tires inflated to 60 psi, no wind

Frame Specifications

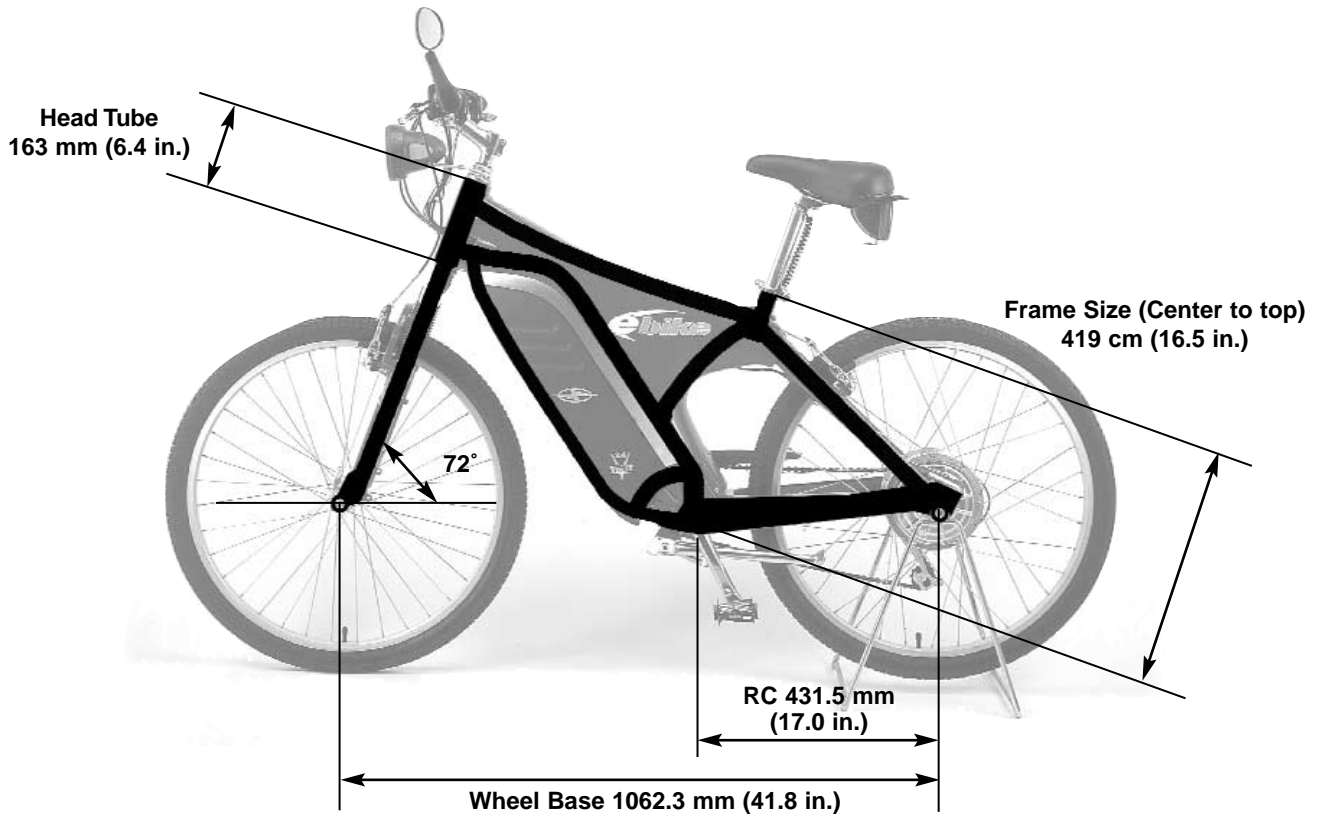

Chapter Three

BATTERY PACK

CHARGING THE BATTERIES

The E-Bike® includes a charger that is an integral part of the battery pack. Batteries can be charged when the battery pack is on-board the E-Bike® or when the battery pack is removed for remote charging.

To assure maximum battery life, always fully charge the battery after each ride. The battery will be damaged if it is allowed to totally discharge. To prevent total battery discharge during extended periods of non-use, remove the battery pack and store it in a cool, dry place. Optimal storage temperature is 32-86° F (0-30° C). Long-term storage outside this temperature range will result in accelerated battery discharge, which could lead to battery damage. A stored battery should be recharged at least every three months to help maintain a full charge, maximum capacity, and maximum cycle life.

IMPORTANT NOTICES

- **Always charge the battery pack immediately after each use. Failure to do so within 72 hours may damage the battery.**
- **The charger can remain plugged-in for trickle-charge purposes for up to 72 hours.**
- **For storage periods over 3 months, the battery pack should be checked and fully charged every 3 months.**
- **Optimal storage temperature is 32-86° F (0-30° C). Long-term storage outside this**

temperature range will result in accelerated battery discharge which, could lead to battery damage.

- **Always pedal assist your E-Bike® when the pedal-assist beep sounds.**
- **If the overheat warning beep sounds and the yellow LED flashes, pedal your E-Bike® until the good beep sounds and the yellow LED stops flashing. Do not turn the power knob from OFF to ON repeatedly in an effort to override the overheat protection function. This may cause motor or controller damage, and it will void the warranty.**

On-board Charging

1. Be sure the power knob is turned OFF.
2. Turn the battery-compartment latches clockwise, and open the door.
3. Retrieve the charging cord from the compartment above the bottom bracket.

WARNING

The charger is equipped with a cooling fan. If the cooling fan does not operate when the LED is red, unplug the charger from the electrical outlet immediately. Determine why the fan is not operating before charging the battery pack. Replace the charger if necessary.

4. Plug the female end of the charging cord into the receptacle on the battery charger (Figure 1).

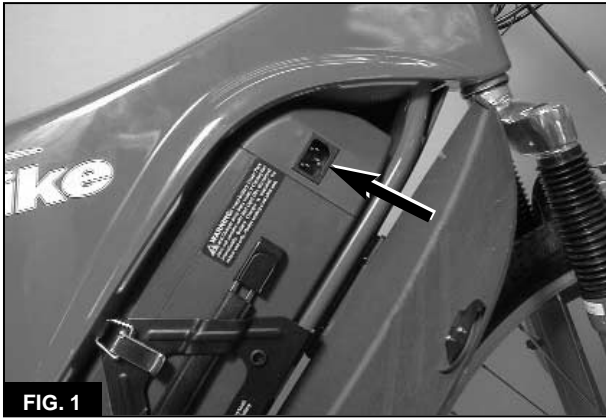

FIG. 1

NOTE

When a battery is new, the LED may rapidly flicker instead of turning to green. This is not a problem. The battery is fully charged and can be used. The flicking will cease after several use/recharge cycles.

5. Plug the male end of the charging cord into a standard 110V/60 cycle electrical outlet. The charger LED turns red and the cooling fan automatically turns on. The LED switches to green and the cooling fan turns off when the battery pack is fully charged.

If the LED switches to flashing orange, unplug the charger immediately. Check for an intermittent connection in the charging cord, at the battery terminals, or in the battery-to-charger connections. If there are no intermittent connections, replace the battery.

If the LED does not illuminate, unplug the charger immediately. Replace the charger.

If the charger operates (the LED turns red and the fan operates), but the charger does not turn off after four hours, unplug the charger immediately. Perform the charger test described later in this chapter. If the charger is faulty, replace it. If the charger is working, replace the battery.

Remote Charging

1. Remove the battery pack from the E-Bike®.
2. Set the battery pack on its side so the battery-pack cover faces up and the handle is to the side.
3. Retrieve the charging cord from the compartment above the bottom bracket.

WARNING

The charger is equipped with a cooling fan. If the cooling fan does not operate when the LED

is red, unplug the charger from the electrical outlet immediately. Determine why the fan is not operating before charging the battery pack. Replace the charger if necessary.

4. Plug the female end of the charging cord into the receptacle on the battery charger.

NOTE

When a battery is new, the LED may rapidly flicker instead of turning to green. This is not a problem. The battery is fully charged and can be used. The flicking will cease after several use/recharge cycles.

5. Plug the male end of the charging cord into a standard 110V/60 cycle electrical outlet. The charger LED turns red and the cooling fan automatically turns on. The LED switches to green and the cooling fan turns off when the battery pack is fully charged.

If the LED switches to flashing orange, unplug the charger immediately. Check for an intermittent connection in the charging cord, at the battery terminals, or in the battery-to-charger connections. If there are no intermittent connections, replace the battery.

If the LED does not illuminate, unplug the charger immediately. Replace the charger.

If the charger operates (the LED turns red and the fan operates), but the charger does not turn off after four hours, unplug the charger immediately. Perform the charger test described later in this chapter. If the charger is faulty, replace it. If the charger is working, replace the battery.

REPLACING THE BATTERY

The battery pack contains a sealed lead-acid battery. The following procedure describes how to remove and replace the battery.

WARNING

Never use a battery that is cracked or broken. Battery acid is highly corrosive and can cause severe burns if it comes in contact with your eyes or skin.

Removal

1. Remove the battery pack from the E-Bike®.
2. Remove the two cover screws from the battery pack, and remove the cover.

3. Remove the mounting screw, and disconnect the blue negative lead from the negative (-) battery terminal. Be sure to remove the washer.
4. Repeat the above procedure and disconnect the red positive lead from the positive (+) battery terminal.

NOTE

Perform the following when disconnecting a bullet connector.

- a. Pull back the seal to expose the bullet connector.
- b. Pull the male and female halves of the connector and separate the connector.

5A. On batteries with an external thermal switch, disconnect the bullet connectors on the two red wires from the thermal switch and disconnect the bullet connector on the black charger-to-battery wire. See **Figure 2**.

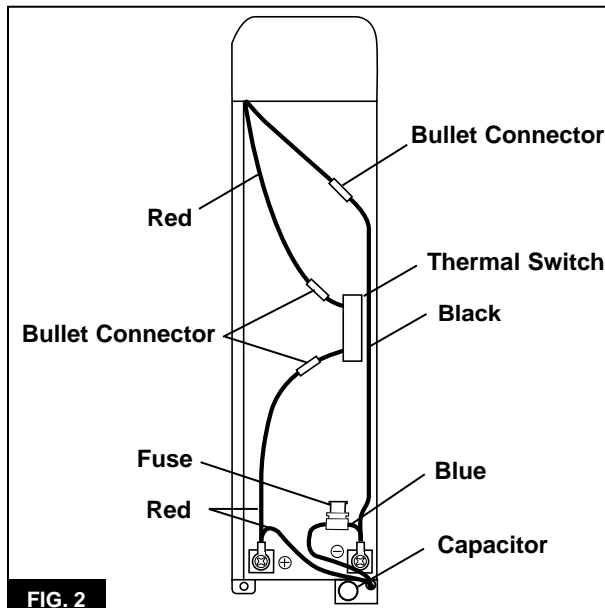

FIG. 2

- 5B. On batteries without an external thermal switch, disconnect the bullet connector on the red charger-to-battery wire and the connector on the black charger-to-battery wire.
6. Invert the battery pack, and remove the battery.

NOTE

Contact your state or local agency for information on proper battery disposal.

7. Properly dispose of the old batteries.

Installation

1. Gently lower the battery into the battery case so the end with the terminals

(**Figure 3**) sits in the bottom of the case (the end with the capacitor). Be sure the battery is properly seated in the battery case.

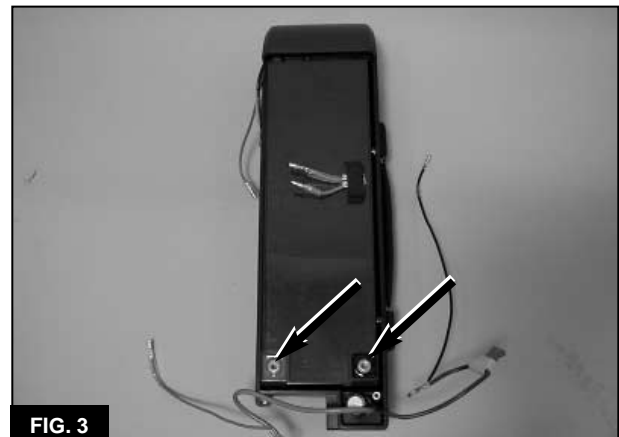

FIG. 3

NOTE

Perform the following when connecting a bullet connector.

- a. Press the male and female connector halves together.
- b. Roll the seal over the connector.

2A. On batteries with an external thermal switch, refer to **Figure 2** and perform the following:

- a. Remove the thermal switch from the old battery and install it on the new one.
- b. Connect the bullet connector on one red wire from the thermal switch to the red wire from the charger.
- c. Connect the bullet connector on the second red wire from the thermal switch to the red wire from the battery.
- d. Connect the bullet connector on the black charger-to-battery wire.

2B. On batteries without an external thermal switch, connect the bullet connectors on the red charger-to-battery wire and connect the bullet connectors on the black charger-to-battery wire.

3. Connect the red positive lead to the positive (+) battery terminal. Place the washer on top of the lead's eyelet, and tighten the mounting screw securely.
4. Check the connection by trying to rotate the lead's connector around the mounting screw. If the connector moves, remove the mounting screw and reinstall the lead with two washers on top of the eyelet.
5. Repeat steps 3 and 4, and connect the blue negative lead to the negative (-) battery terminal.

6. Fit the cover onto the battery pack. Be sure no wire is pinched beneath the cover.
7. Apply Loctite 242 (blue) to the threads of the two cover screws, and secure the cover in place.

REPLACING THE CHARGER

Two types of chargers are used on these models: an IC charger and a non-IC charger. To determine which type of charger you have, look at the model number on the charger cover. An IC charger has the letters "IC" at the end of the model number. A non-IC charger does not.

A non-IC charger must be installed in a battery pack with an external thermal switch. An IC charger can be installed with or without an external thermal switch.

Removal

WARNING

Make sure the charger is not plugged in during service.

1. Remove the battery from the battery pack.
2. Remove the three charger-cover screws that secure the cover to the vent (A, **Figure 4**).

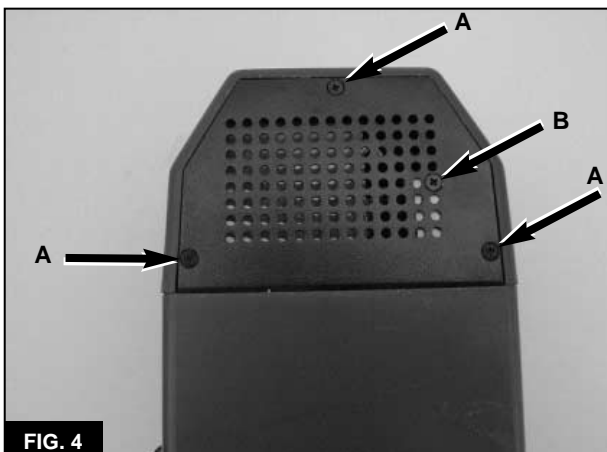

3. Lift the cover from the charger, and disconnect the three electrical connectors from the charger board.
4. Remove the screw that secures the charger board to the bracket (B, **Figure 4**).
5. Remove the three charger-board mounting screws (**Figure 5**), and remove the charger board. Do not lose the spacer (A, **Figure 6**) from each mounting stud.

Installation

1. Be sure the insulator (B, **Figure 6**) is in place in the battery pack.
2. If removed, install the spacer (A, **Figure 6**) onto each mounting stud in the battery pack.
3. Set the charger board into place on the mounting studs. Secure the board in place with the charger-board mounting screws and washer (**Figure 5**).

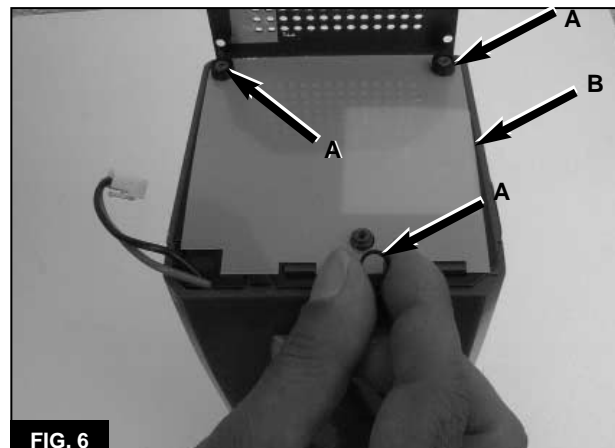
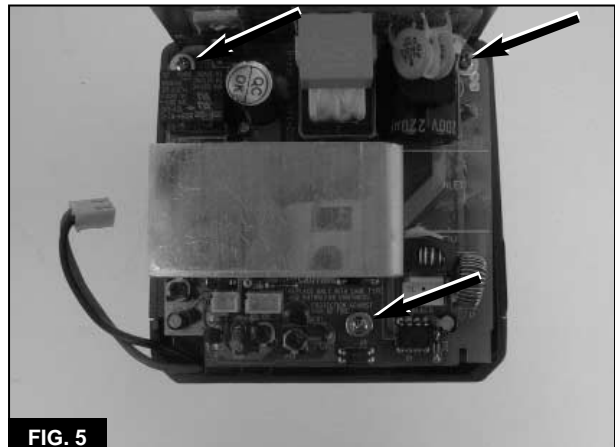

4. Secure the board to the bracket with the mounting screw (B, **Figure 4**).
5. Plug the connectors from the cover into their mates in the charger board.
6. Fit the cover in place over the charger board. Be sure the two charger wires are not pinched under the cover.
7. Secure the cover in place with the three charger-cover screws (A, **Figure 4**).
8. Reinstall the battery and the battery-pack cover.

BATTERY PACK

Removal

1. Turn the power knob OFF.
2. Open the battery compartment door.
3. Release the gate latch, and open the battery gate.
4. Use the handle to pull the battery pack from the compartment. Be sure to support the bottom of the battery pack with your free hand.

Installation

1. Set the lower end of the battery pack into the battery compartment, and tilt the battery into place.
2. Close the gate over the battery, and secure the gate latch.
3. Close the battery compartment door, and turn the latches counterclockwise.

BATTERY PACK TEST

Charger operation test

1. Plug the female end of the charging cord into the port on the charger.
2. Plug the male end into a 110V/60 cycle outlet
3. Watch the battery charger LED and perform the indicated procedure.
 - a. If the battery charger LED does not illuminate, the charger is faulty and should be replaced. Unplug the charging cord, and check the battery voltage (before charging) as described below.
 - b. If the battery charger LED turns to red and the cooling fan is not operating, the charger is faulty and should be replaced. Unplug the charger, and check the battery voltage (before charging) as described below.
 - c. If the battery charger LED turns red and the cooling fan operates, perform the charger output test described below.
 - d. If the battery charger LED turns green, perform the charger output test described below.
 - e. If the LED switches to flashing orange, unplug the charger immediately. Check for an intermittent connection in the charging cord, at the battery terminals, or in the battery-to-charger connections.

If there are no intermittent connections, replace the battery.

Charger Output Test

1. Remove the cover from the battery pack.
2. Connect a digital voltmeter's positive (+) test probe to the positive (+) battery terminal, and connect the voltmeter's negative (-) test probe to the battery negative (-) terminal as shown in **Figure 7**. Note the reading on the voltmeter.

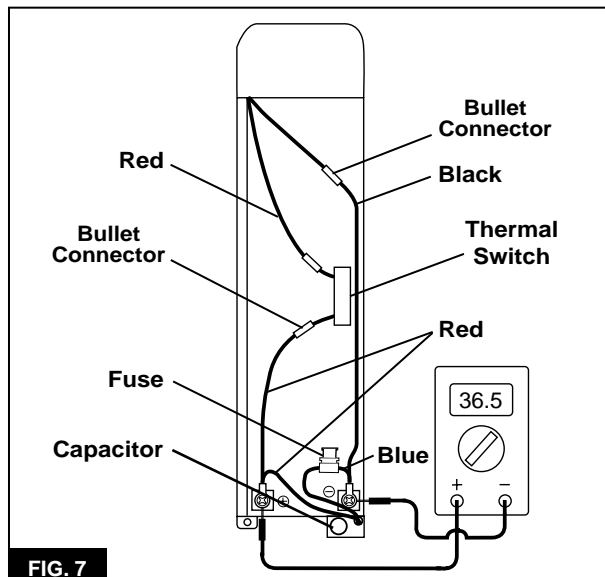

FIG. 7

3. With the voltmeter still connected as described in step 2, plug the charger into a 110V/60 cycle outlet. Note the reading on the voltmeter.
4. Compare the two readings.
 - a. If the reading is higher when the charger is plugged in, the charger is operating properly. Perform the battery voltage test (before charging).
 - b. If the two readings are the same, the charger has failed and should be replaced.

Battery Voltage Test, Before Charging

1. Let the battery stand for one hour.
2. Remove the cover from the battery pack.
3. Connect a digital voltmeter's positive (+) test probe to the positive (+) battery terminal, and connect the voltmeter's negative (-) test probe to the battery negative (-) terminal as shown in **Figure 7**.
4. Note the reading on the voltmeter.
5. If the reading is less than 31.5 volts, perform the battery voltage test (after charging).

Battery Voltage Test, After Charging

NOTE

The charger must be operational for this test to be valid. Perform the charger output test before performing this test.

1. Charge the battery as described in this chapter.
2. Unplug the charger, and let the battery stand for one hour.

3. Remove the cover from the battery pack.
4. Connect a digital voltmeter's positive (+) test probe to the positive (+) battery terminal, and connect the voltmeter's negative (-) test probe to the battery negative (-) terminal as shown in **Figure 7**.
5. Note the reading on the voltmeter.
6. The reading should be 36.5 volts or greater. If the reading is less than 36.5 volts, the battery is faulty and should be replaced.

Chapter Four

HANDLEBAR and CONTROLS

HANDLEBAR POSITION

NOTE

The handlebar may be adjusted to suit the rider's preference. The following procedure describes how to set the handlebar to the stock position.

1. Loosen the handlebar-binder bolts (A, **Figure 1**).

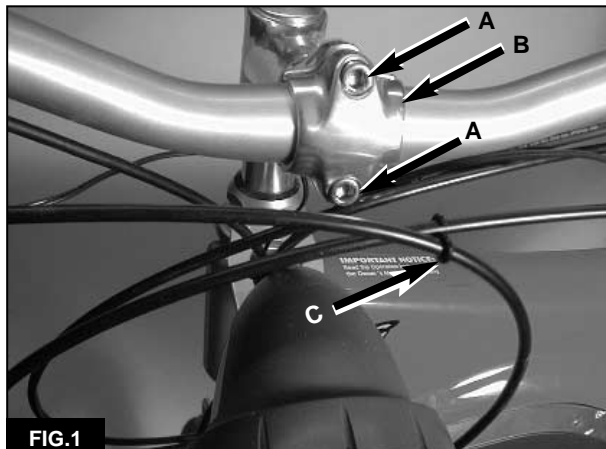

2. Rotate the handlebar so the ends point down slightly. The handlebar grip should form a 10-20° angle with a line that parallels the floor. See **Figure 2** for LE models; **Figure 3** for PE & SX models.

3. Be sure the knurled portion of the handlebar is centered within the handlebar binder.
4. Tighten the handlebar-binder bolts to the torque specification in Table 4.

HANDLEBAR HEIGHT ADJUSTMENT

1. Loosen the stem-binder bolt three or four turns counterclockwise (A, **Figure 4**). If the bolt rises from the steering stem, strike the bolt with a plastic mallet to force the stem wedge down.

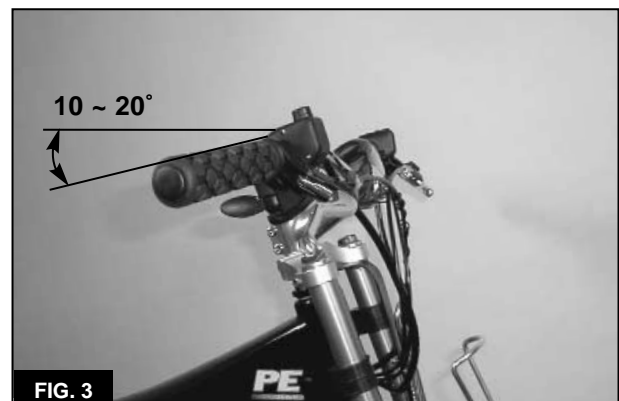
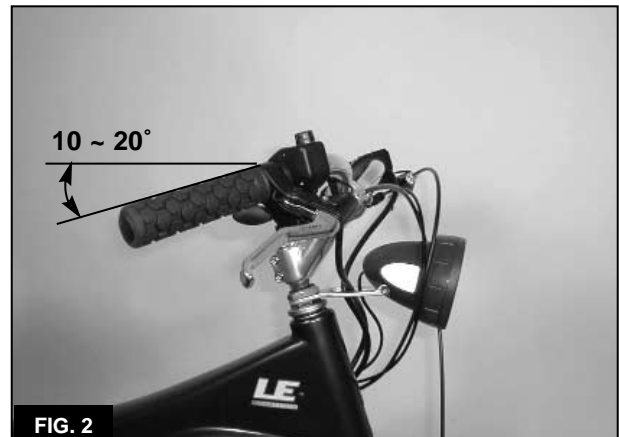

WARNING

The "Minimum Insert" mark on the handlebar stem must not sit above the top of the headset.

2. Raise or lower the stem within the fork column until the handlebar is at the desired height.
3. Rotate the handlebar from side to side, and align the handlebar with the wheel or fork dropouts.
4. Tighten the stem-binder bolt to the torque specification in Table 4.

HANDLEBAR REPLACEMENT**Removal**

1. Note how the brake cables, shifter cable, and electrical wires are routed around the headlight. On PE and SX models, note how they are routed past the fork tubes. All wires and cables will have to be rerouted along their original paths during installation.
2. Remove the following components from the right handlebar:
 - a. The handlebar grip.
 - b. The brake-lever housing
 - c. The throttle control and throttle stop.
3. Remove the following from the left handlebar:
 - a. The mirror.
 - b. The handlebar grip
 - c. The shifter.
 - d. The brake-lever housing.
 - e. The accessory control.
4. Remove the two handlebar-binder bolts (A, **Figure 1**).
5. Remove the handlebar clamp (B, **Figure 1**).

Installation

1. Fit the handlebar into place in the binder on the handlebar arm. Be sure the knurled portion of the handlebar is centered in the binder.
2. Fit the handlebar clamp into place around the handlebar.
3. Apply Loctite 242 (blue) to the threads of the handlebar-binder bolts, and install the bolts finger tight.
4. Position the handlebar as described in this chapter, and tighten the handlebar-binder bolts to the torque specification in Table 4.

5. Install the throttle control as described in this chapter.
6. Install the accessory control as described in this chapter.

THROTTLE CONTROL (RIGHT SIDE)**Removal**

1. Remove the battery from the battery compartment.
2. Remove the right side cover from the E-Bike®.
3. Pull the cable inlet cover around the head tube, and remove the cable inlet cover from the left side cover.
4. Disconnect the throttle control connector (C, **Figure 5**) from the controller lead. Note how the throttle control wire is routed through the frame. The new wire will have to be rerouted along the same path.

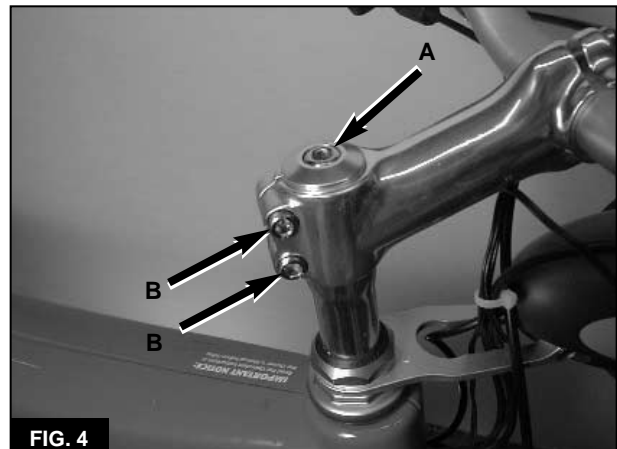

FIG. 4

5. Pull the wire so the connector passes through the frame and emerges at the cable inlet in the left side cover (**Figure 6**).

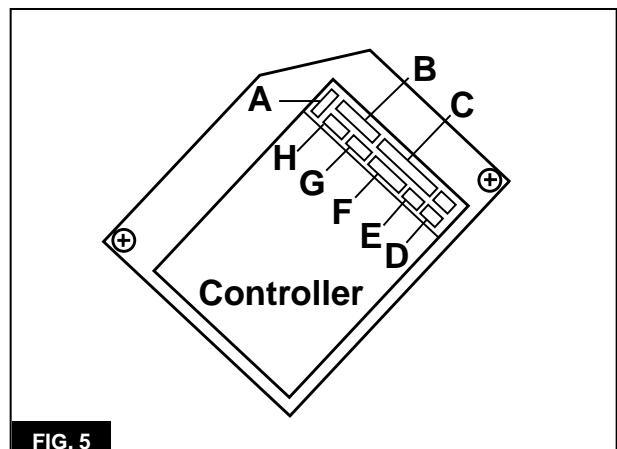

FIG. 5

6. Roll and remove the right handlebar grip off the handlebar.

7. Disconnect the front brake cable from the S-hook (C, **Figure 1**). Note how the front brake cable is routed around the headlight (LE and SX models) or around the battery holder (PE models). The cable will have to be routed along the same path during assembly.

8. Loosen the right-brake-lever clamp bolt, and slide the brake lever body from the right handlebar. Guide the front brake cable around the headlight (LE or SX models) as you remove the brake lever.

9. Lay the brake lever over the frame top tube so it is out of the way. Do not severely bend or kink the cable.

10. Loosen the set bolt on the throttle control.

11. Slide the throttle control off the handlebar. On LE and SX models, pull the control wire free of the bracket (**Figure 7**).

Installation

1. Fit the throttle stop onto the bottom of the throttle control (**Figure 8**).

2. Slide the throttle control assembly onto the right handlebar.

3. On the LE and SX models feed the connector end of the control wire through the cutout in the headlight bracket (**Figure 7**).

4. Feed the cable around the head tube, through the cable inlet in the left side cover, and plug the connector to its mate (C, **Figure 5**) from the controller.

5. Slide the right-brake-lever body onto the right handlebar. Guide the front brake cable around the headlight (LE and SX models) as you install the brake lever body.

6. Finger tighten the clamp bolt to hold brake body in place. Use the S-hook to secure the



FIG. 6

front brake cable to the shifter cable (C, **Figure 1**).

7. Roll the right handlebar grip onto the handlebar until the grip is flush with the end of the handlebar.

8. Slide the brake lever body against the handlebar grip. Position the brake lever as described in Chapter Five, and torque the clamp bolt to the specification in Table 4.

9. Slide the throttle control assembly against the brake lever. Rotate the throttle control so the LEDs point to the rider's eyes. Tighten the clamp bolt so there is enough friction to hold it in place. Do not overtighten the clamp bolt.



FIG. 7

10. Operate the throttle lever. Be sure the brake lever body does not interfere with the movement of the lever. Also be sure the lever hits the throttle stop.

11. Reinstall the right side cover.

ACCESSORY CONTROL (LEFT SIDE)

Removal

1. Remove the battery from the battery compartment.

2. Remove the right side cover from the E-Bike®.

3. Pull the cable inlet cover around the head tube, and remove the cable inlet cover from the left side cover.

4. Disconnect the accessory control connector (B, **Figure 5**) from the controller lead. Note how the accessory control wire is routed through the frame. The new wire will have to be rerouted along the same path.

5. Pull the wire so the connector passes through the frame and emerges at cable inlet in the left side cover (**Figure 6**).

6. Loosen the mirror-mounting bolt (**Figure 10**), and remove the mirror from the handlebar end.



FIG. 8

7. Roll the left handlebar grip from the handlebar. Do not lose the shim that sits between the handlebar grip and the shifter body.

8. Disconnect the shifter cable from the S-hook (**C, Figure 1**). Note how the cable is routed around the headlight (LE and SX) or around the battery holder (PE models). The cable will have to be routed along the same path during assembly.



FIG. 9



FIG. 10

9. Loosen the shifter clamp bolt, and slide the shifter body from the handlebar (**Figure 11**). Guide the shifter cable around the headlight as you remove the shifter. Lay the shifter over the

frame top tube so it is out of the way. Do not severely bend or kink the cable.



FIG. 11

10. Loosen the clamp bolt on the brake-lever body (**Figure 12**), and remove the body from the handlebar. Guide the brake cable around the headlight (LE or SX models) or the battery holder (PE models) as you remove the lever body. Lay the lever body over the frame top tube so it is out of the way.



FIG. 12

11. Loosen the clamp bolt on the accessory control. Slide the control off the handlebar. On the LE and SX models, pull its wire free of the headlight bracket **Figure 7**.

Installation

1. Slide the accessory control onto the left handlebar.
2. On the LE or SX models, feed the connector end of the accessory control wire through the cutout in the headlight bracket (**Figure 7**).
3. Feed the wire around the head tube, through the cable inlet in the left side cover, and plug the connector into its mate (**B, Figure 5**) from the controller.
4. Slide the rear-brake-lever body onto the left handlebar. Take care to guide the rear brake cable around the headlight.

5. Slide the shifter body onto the left handlebar. Guide the shifter cable around the headlight (LE or SX models) or battery holder (PE models).
6. Slide the shim onto the handlebar. Roll the handlebar grip onto the handlebar until the grip is flush with the handlebar end.
7. Slide the shifter against the handlebar grip/shim.
8. Position the shifter body as described in Chapter Six, and tighten the shifter-body clamp bolt to the torque specification in Table 4.
9. Slide the brake-lever body against the shifter. Position the brake lever as described in Chapter Five, and torque the brake-lever clamp bolt to the specification in Table 4.
10. Fit the mirror mount into the handlebar end (**Figure 10**). Position the mirror, and tighten the mirror mounting bolt to the torque specification in Table 4.
11. Slide the accessory control against the brake lever. Rotate the control on the handlebar to the same relative position as the throttle control housing. Tighten the clamp bolt so there is enough friction to hold it in place. Do not over tighten the clamp bolt.
12. Use the S-hook to secure the shifter cable to the front brake cable (**C, Figure 1**).
13. Reinstall the cable inlet cover and right side cover.

HEADSET

A 36-mm spanner (Park Tool HCW-15) is required for servicing the headset.

Disassembly

1. Mark the stem height with tape so it can be easily reset to the correct height during assembly.
2. Break the stem-binder bolt loose (**A, Figure 4**).
3. Remove the front wheel.
4. Disconnect the brake cable from the front brake lever by performing the following.
 - a. Loosen the adjuster locknut (**A, Figure 13**) at the brake lever. Turn the adjusting barrel (**B, Figure 13**) and the locknut until their slots align with the slot in the brake lever body.
 - b. Pull the cable housing from the adjusting barrel, and slide the inner cable through

the slots in the brake lever, adjusting barrel and adjuster locknut.

- c. Disconnect the inner-cable end from the anchor (**C, Figure 13**) on the brake lever.

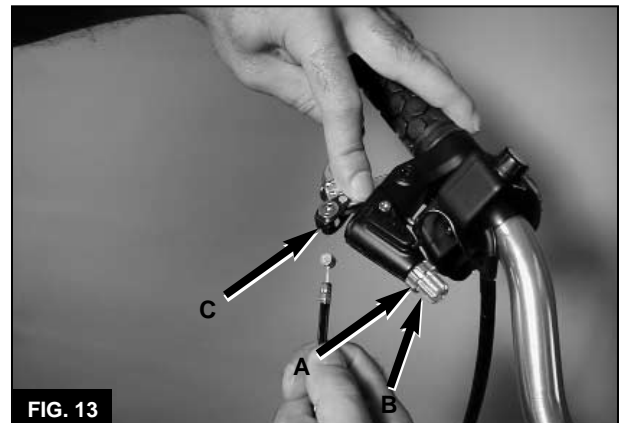

FIG. 13

5. Loosen the handlebar binder bolts (**A, Figure 1**), remove the handlebar clamp, and remove the handlebar from the binder on the handlebar arm.
6. Remove the stem/handlebar arm assembly from the fork column.

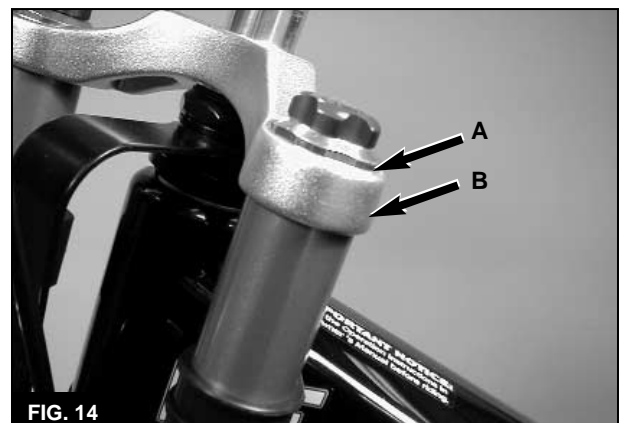

FIG. 14

7. On PE and SX models, perform the following.
 - a. Note the position of the stanchion caps (**A, Figure 14**) relative to the upper fork bridge (**B, Figure 14**). The fork bridge will have to be reinstalled in the same position during assembly.
 - b. Loosen each stanchion clamp bolt (**A, Figure 15**) and loosen the fork bridge clamp bolt (**B, Figure 15**).
 - c. Carefully slide the upper fork bridge off each stanchion and remove the fork bridge. Do not lose the fork bridge collar.
8. Use a bungee cord or wire to suspend the handlebar assembly from the frame.
9. On PE models, remove the bolt (**Figure 16**) that secures the battery holder to the lower fork bridge.

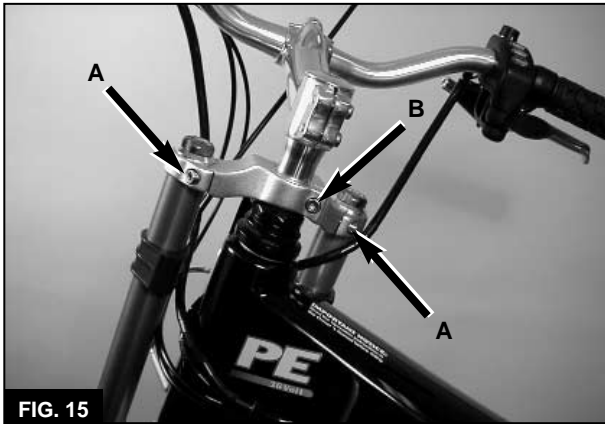

FIG. 15



FIG. 16

10. Visually inspect the position of cone in the adjustable race and in the fork crown. Note how far each cone protrudes from its respective cup (**Figure 17**). This will help during assembly.

11. Remove the headset locknut with the Park 36 mm wrench (**Figure 18**), and then remove the washer.

12A. On LE and SX models, remove the headlight bracket from the fork column.

12B. On PE models, remove the lock ring and the battery holder from the fork column.

13. Support the forks, and remove the adjustable race from the fork column.

NOTE

Each bearing must be reinstalled with the proper orientation during assembly. Look for the lower bearing when removing the forks. The bearing may come out with the fork-crown race or it could remain behind in the head tube.

14. Carefully lower the forks from the head tube.

15. Remove the lower bearing (A, **Figure 19**). Note how the bearing is oriented (the closed

side of the retainer facing up toward lower head-tube race). The bearing will have to be installed in this position during assembly.

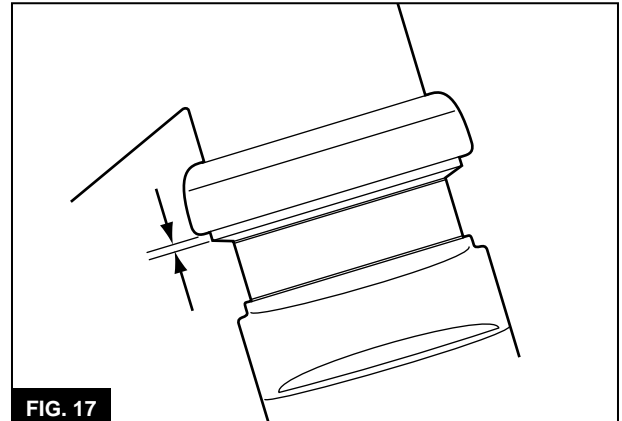

FIG. 17



FIG. 18

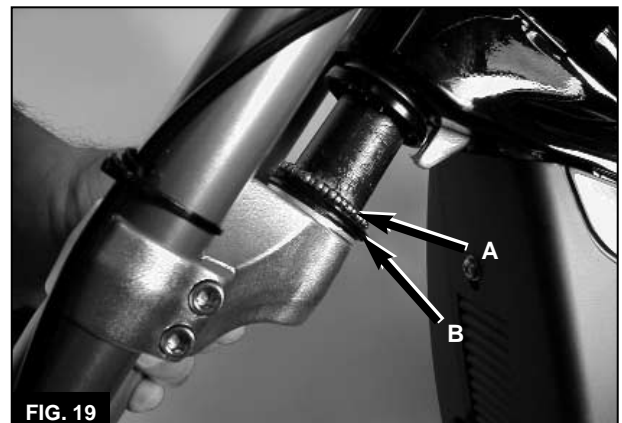

FIG. 19

16. Remove the rubber seal (B, **Figure 19**) from the fork-crown race. Note how the seal is oriented. It will have to be installed in this position during assembly.

17. Remove the upper bearing (**Figure 20**) from the head tube. Note how the bearing is oriented (the closed side of the retainer facing down toward the upper head-tube race). The bearing will have to be installed in this position during assembly.



FIG. 20

Assembly

1. Clean the bearings, head-tube races, fork-crown race, and adjustable race with solvent.
2. Lightly coat the upper head-tube race and the lower head-tube race with grease. A 1-mm bead in each race should be sufficient.
3. Pack the bearings with grease.

NOTE

The grease in the lower head-tube race should hold the bearing in place during assembly.

4. Press each bearing into the grease in the head-tube. Be sure the closed side of each bearing faces the race in the head tube (**Figure 20**).
5. Set the seal in place on the fork-crown race. Be sure the seal is oriented in the same direction you noted during removal.
6. Apply grease to the threads of the fork column.
7. Fit the fork column up into the head tube.
8. Thread the adjustable race (**A, Figure 21**) onto the fork column.
9. Let the forks drop down so the forks are supported by the adjustable race.
10. Turn the adjustable race until the fork column is drawn up into the head tube.
11. Inspect the position of each cone relative to its race. Each cone should be in the position you noted during removal.
- 12A. On PE models, fit the battery holder over the fork column and install the lock ring. Be sure the tab in the lock ring engages the slot in the fork column (**B, Figure 21**).
- 12B. On LE and SX models, fit the headlight bracket onto the fork column. Be sure the tab in the bracket engages the slot in the column (**B, Figure 21**).

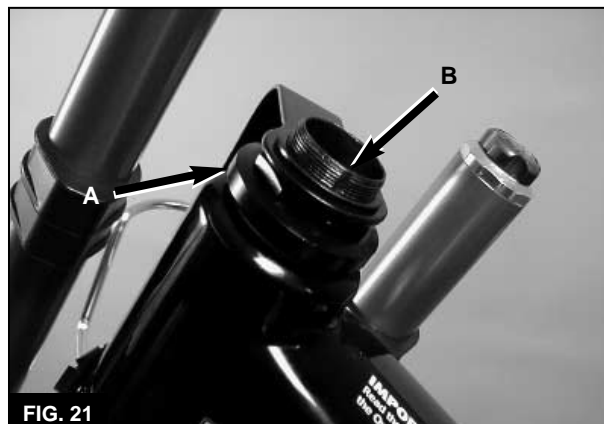

FIG. 21

13. Install the washer and thread the headset locknut onto the fork column.
14. Torque the headset locknut to the specification in Table 4.
15. On PE and SX models, install the upper fork bridge by performing the following.
 - a. Insert the collar into the center hole in the upper fork bridge. Be sure to install the collar into the bottom of the fork bridge.
 - b. Carefully slide each end of the fork bridge over a stanchion until the fork bridge rests on the headset locknut.
 - c. Insert the steering stem through the fork bridge and into the fork column to assure that the fork bridge is properly centered.
 - d. Press the fork bridge down to assure that the fork bridge is completely installed. When properly installed, the bottom of the cap (**A, Figure 14**) on each stanchion tube should be flush with the top of the fork bridge (**B, Figure 14**).
 - e. Evenly tighten the two stanchion clamp bolts (**A, Figure 15**) and the fork bridge clamp bolt (**B, Figure 15**). Torque the bolts to the specification in Table 4.
16. Set the stem to the height you noted during disassembly. Be sure the handlebar arm is centered, and tighten the stem-binder bolt (**A, Figure 4**) securely.
17. Check the headset free play by performing the following.

NOTE

Do not check for headset free play by grasping the bottom of the forks. Normal movement in the suspension could be misinterpreted as bearing free play.

- a. On LE models, grasp the fork crown with one hand (the upper stanchions above the fork boots) and grasp the lower slid-

- er with the other. On PE and SX models, grasp a stanchion between the upper and lower fork bridges with one hand and grasp the lower slider with the other.
- b. Try to move the forks back and forth. You should not notice any play in the headset.
 - c. If free play is noticed, adjust the headset by tightening the adjustable race.
 - d. If looseness cannot be eliminated without the bearings becoming excessively tight, the headset must be overhauled.
18. Install the front wheel.
 19. Install the handlebar by performing the following.
 - a. Fit the handlebar into place in the binder on the handlebar arm. Be sure the knurled portion of the handlebar is centered in the binder.
 - b. Fit the handlebar clamp into place around the handlebar.
 - c. Apply Loctite 242 (blue) to the threads of the handlebar-binder bolts, and install the bolts finger tight.
 - d. Position the handlebar as described in this chapter, and tighten the handlebar-binder bolts to the torque specification in Table 4.
 20. Check the height of the stem, and torque the stem binder bolt to the specifications in Table 4.
 21. Connect the brake cable to the anchor (C, **Figure 13**) on the brake lever. Align the slots in the adjusting barrel and adjuster locknut with the slot in the brake body. Slide the inner wire through the aligned slots, and fit outer cable into the end of the adjusting barrel.
 22. Check for tight bearings by performing the following.
 - a. Turn the handlebars from side to side. The forks should turn smoothly with no binding. The bearings are too tight if you feel jerky, incremental movement instead of a smooth, fluid motion.
 - b. Lift the E-Bike[®] by the top frame tube, and watch the front wheel. It should freely rotate to one side or the other. The bearings are too tight if the wheel does not fall to one side when you lift the E-Bike[®].
 - c. If necessary, adjust the headset by loosening the adjustable race.
 23. Adjust the brake lever free play as described in Chapter Five.

Chapter Five

BRAKES

V-BRAKES

NOTE

When working on the brake calipers and pads, the terms "left" and "right" refer to the technician's point of view when standing in front of the E-Bike® and looking at the front brake caliper or when standing behind the E-Bike® and looking at the rear brake caliper.

BRAKE CABLE REPLACEMENT

Removal

1. Squeeze the caliper arms together, and disconnect the cable guide from the bracket on the left caliper arm (A, **Figure 1**).

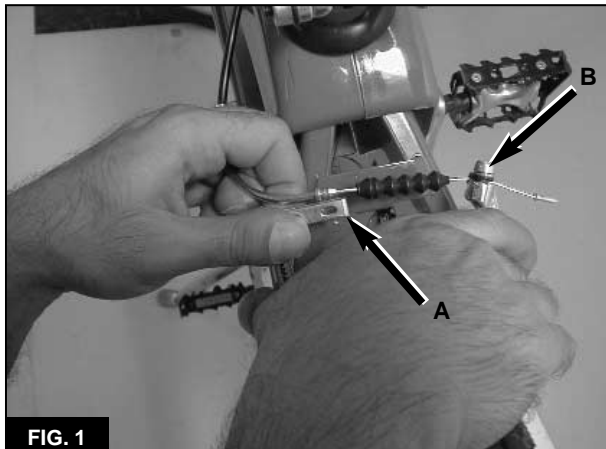

FIG. 1

2. Loosen the caliper pinch bolt (B, **Figure 1**), and free the brake-cable inner wire from the pinch mechanism.

3. Loosen the adjuster locknut at the brake lever.

4. Turn the adjusting barrel and the adjuster locknut until their slots align with the slot in the brake lever body.

5. Pull the cable housing from the adjusting

barrel, and slide the inner cable through the slots in the brake lever, adjusting barrel, and adjuster locknut (**Figure 2**).



FIG. 2

6. Pull the brake lever toward the handlebar, and disconnect the inner-cable end (**Figure 3**) from the cable anchor on the lever.



FIG. 3

NOTE

If the cable housing is not damaged, the rear-brake inner wire can be removed and replaced without removing the cable housing or the left side cover.

7. Remove the brake cable. If you are replacing the rear brake cable, remove the left side cover, and remove the cable from the rear inlet on the side cover.

Installation

1. At the brake lever, align the slots in the brake lever, adjusting barrel, and the adjuster locknut.
2. Pull the brake lever to the handlebar, and fit the inner cable barrel into the cable anchor in the brake lever (**Figure 3**).
3. Slide the inner cable through the slots in the brake lever, adjusting barrel, and the adjuster locknut (**Figure 2**).
4. Turn the adjusting barrel three full turns out from its fully-in position. Turn the adjusting barrel and locknut so their slots do not align with the slot in the brake lever.
5. If necessary, align the brake pads as described in this chapter.
6. Route the cable to the caliper. If you are replacing a rear brake cable, route the cable through the rear cable inlet in the left side cover.
7. Fit the cable-guide tube and rubber boot onto the inner wire.
8. Squeeze the caliper arms together, and connect the cable guide to the bracket (**A**, **Figure 1**) on the left caliper arm.
9. Secure the inner wire in the brake-caliper pinch mechanism by performing the following:
 - a. Feed the brake cable inner wire through the slot in the pinch mechanism.
 - b. Use the fourth-hand cable stretcher (Park Tool BT-2) to pull the inner wire until the combined clearance between each brake pad and the rim equals 2 mm (0.08 in.).
 - c. Tighten the pinch bolt (**B**, **Figure 1**) to the specification in Table 4.
 - d. Crimp a new end cap onto the end of the inner wire.
10. Squeeze and release the brake lever several times, and check the caliper arm balance.
 - a. The brake pads should contact the rim at the same time when the brakes are applied.
 - b. The gap between each pad and the rim should equal 1 mm (0.04 in.) when the brake lever is released.

CAUTION

Do not set the caliper-arm spring tension too high.

- c. If necessary, balance the caliper arms by turning the spring-tension adjuster (**B**, **Figure 4**) on either arm.



FIG.4

11. Adjust the brake lever free play as described in this chapter.

BRAKE LEVER

Removal

1. Remove the handlebar grip from the handlebar.
2. If removing the left brake lever, perform the following:
 - a. Loosen the mounting screw, and remove the mirror from the left-end of the handlebar (**Figure 5**).



FIG. 5

- b. Loosen the set screw on the shifter, and remove the shifter from the handlebar. Lay the shifter over the handlebar so it is out of the way.

3. Squeeze the caliper arms together, and disconnect the cable guide from the bracket on the left caliper arm (A, **Figure 1**).
4. Loosen the adjuster locknut at the brake lever.
5. Turn the adjusting barrel and the adjuster locknut until their slots align with the slot in the brake lever body.
6. Pull the inner cable from the adjusting barrel, and slide the inner cable through the slots in the brake lever, adjusting barrel, and adjuster locknut (**Figure 2**).
7. Disconnect the cable end from the cable anchor in the brake lever (**Figure 3**).
8. Loosen the brake-lever clamp bolt (**Figure 6**), and slide the brake lever body from the handlebar.



FIG.6

Installation

1. Fit a new brake-lever body onto the handlebar, and slide the brake-lever body against the control housing.
2. Turn the adjusting barrel and the adjuster locknut until their slots align with the slot in the brake lever body.
3. Connect the end of the brake-cable inner wire to cable anchor in the brake lever (**Figure 3**).
4. Slide the inner cable through the slots in the brake lever, adjusting barrel and adjuster locknut (**Figure 2**). Fit the cable into adjusting barrel.
5. Turn the adjusting barrel and adjuster locknut so their slots do not align with the slot in the brake lever.
6. Squeeze the caliper arms together, and fit the cable guide into the bracket on the left caliper arm (A, **Figure 1**). Be sure the guide end is completely seated in the bracket.
- 7A. When installing the right brake lever, install

the handlebar grip so it is flush with the handlebar end.

7B. When installing the left brake lever, install the shifter onto the handlebar as described in Chapter Six.

8. Set the brake lever to a 25~35° angle by performing the following:

- a. Set the E-Bike® in an upright position on a level surface.
- b. Slide the brake-lever body against the shifter (left brake lever) or against the handlebar grip (right brake lever).
- c. Rotate the brake lever so it forms a 25~35° angle with a line that parallels the floor (**Figure 7**). Be sure the brake lever body does not interfere with the movement of the throttle lever.
- d. Tighten the brake lever clamp bolt to the torque specification in Table 4.

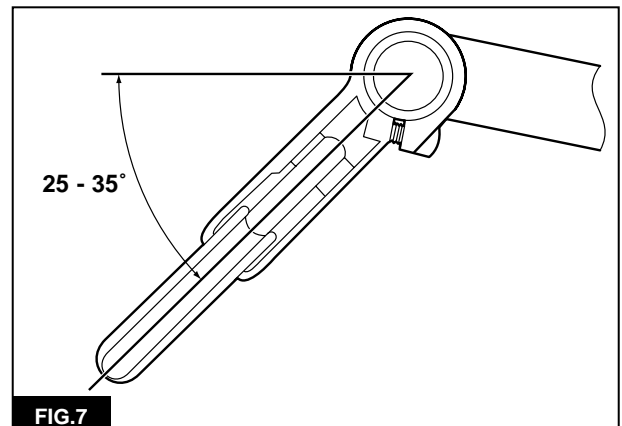

FIG.7

9. Adjust the brake lever free play as described in this chapter.

BRAKE LEVER FREE PLAY ADJUSTMENT

1. Pull the brake lever to simulate a panic stop, and then release the brake lever. Repeat this at least ten times. This assures that all components are properly installed and seated.
2. Pull the brake lever until the brake pads just touch the rim.
3. Measure the clearance between the brake lever and the handlebar grip. This distance should be 25 mm (0.98 in.).
4. If the brake lever clearance is not within specification, adjust the brake lever free play by performing the following:
 - a. Loosen the locknut at the adjusting barrel on the brake lever.
 - b. Turn the adjusting barrel as necessary to adjust clearance to within specification. (Turning the adjuster out tightens the

inner wire; turning the adjuster in loosens the wire.)

- c. When the brake lever is within specification, tighten the adjuster locknut.
5. Squeeze the caliper arms together, and remove the cable guide from the bracket on the left caliper arm (A, **Figure 1**). The brake-lever free play is properly adjusted if the cable guide can be easily removed from the bracket.
6. If you cannot easily release the cable guide from the bracket, perform the following:
 - a. Loosen the locknut and turn the adjusting barrel at the brake lever in (clock wise) one full turn. Try to remove the cable guide again.
 - b. If you still cannot release the cable guide, turn the adjusting barrel in an additional turn.
 - c. If the cable guide still does not release, loosen the pinch bolt (B, **Figure 1**) and release 2-3 mm (0.079-0.118 in.) of inner wire from the pinch mechanism.
 - d. Repeat the adjusting procedure.

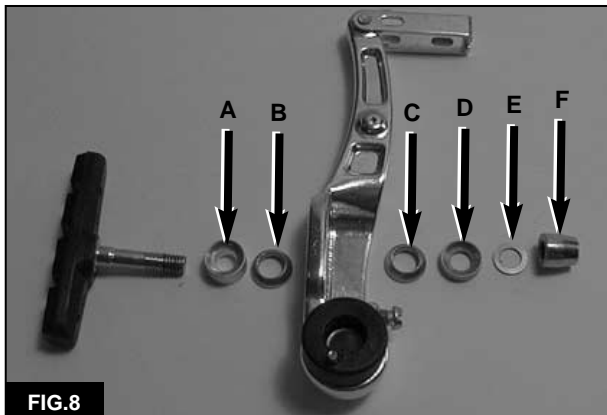

FIG.8

BRAKE PAD

The brake pads in the E-Bike® use a threaded-stud/curved-washer system (**Figure 8**). Convex and concave washers on each side of the brake caliper arm control how the pad is positioned against the wheel.

Removal

NOTE

Do not mix the parts during disassembly. The convex and concave washers become mated through use, and they must be reinstalled in the same position during assembly.

1. Squeeze the caliper arms together, and dis-

connect the cable guide from the bracket on the left caliper arm.

2. Remove the brake pad nut (F, **Figure 8**) from the pad stud .
3. Remove the plain washer (E, **Figure 8**), the concave washer (D, **Figure 8**), and the convex washer (C, **Figure 8**) from the pad stud.
4. Remove the brake pad from the caliper arm.
5. Remove the convex (B, **Figure 8**) and concave washers (A, **Figure 8**) from the brake pad. Discard the old pad. Do not mix the inboard and the outboard parts.

Installation

Brake pads on the E-Bike® are not interchangeable. The pads are marked left ("L") and right ("R"). Be sure to install a left pad on a left caliper arm and a right pad on a right arm.

1. Find the left ("L") or right ("R") marking on the new brake pad. Be sure to install the correct pad onto the caliper arm.
2. Install the inboard concave washer (A, **Figure 8**) onto the stud of the new brake pad. The flat side of the washer must face the brake pad.
3. Install the inboard convex washer (B, **Figure 8**) onto the pad stud so the convex side faces the concave washer.
4. Fit the brake-pad stud through the cutout in the caliper arm.
5. Slide the convex washer (C, **Figure 8**) onto the pad stud so the convex side faces out away from the caliper arm.
6. Install the concave washer (D, **Figure 8**) so the flat side of the washer faces out.
7. Install the plain washer (E, **Figure 8**).
8. Apply Loctite to the threads of the pad stud, and install the brake pad nut (F, **Figure 8**). Tighten the nut to the torque specification in Table 4.
9. Align the brake pads as described in this chapter.

BRAKE PAD ALIGNMENT

Brake efficiency is affected by four parameters: toe, vertical-angle, tangent, and height.

Toe alignment determines how the brake-pad face sits against the brake surface of the rim. When properly adjusted, a pad's trailing end (the end facing the front) should reach the rim before the leading end (**Figure 9**). Vertical alignment sets the position of the pad's vertical

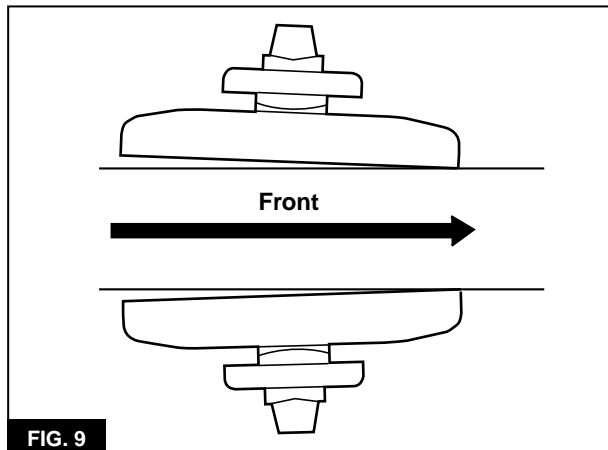

FIG. 9

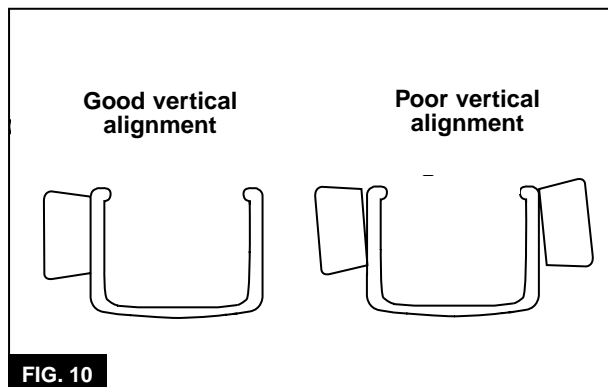

FIG. 10

plane relative to the brake surface of the rim (**Figure 10**). The pad's vertical plane should parallel the vertical plane of the brake surface of the rim.

Tangent alignment sets the position of the horizontal axis of the pad relative to the wheel rim. The distance between the top of the wheel rim and the top of the pad should be the same at each end of the pad. (**Figure 11**)

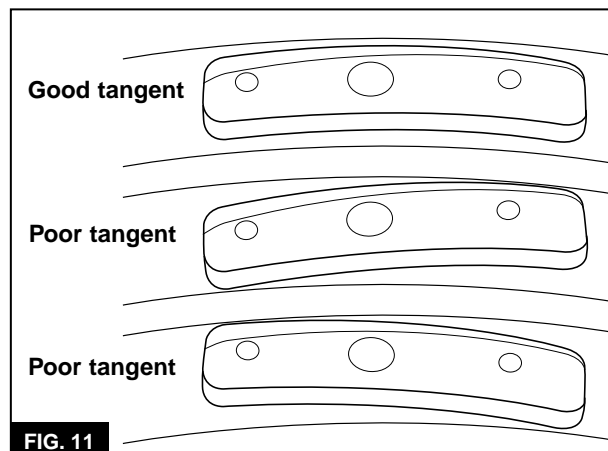

FIG. 11

Height adjustment locates the brake pad on the rim brake surface. When height is properly adjusted, the pad will press as near to the top of the rim as possible without interfering with the tire (**Figure 12**). Pad alignment procedure is described below.

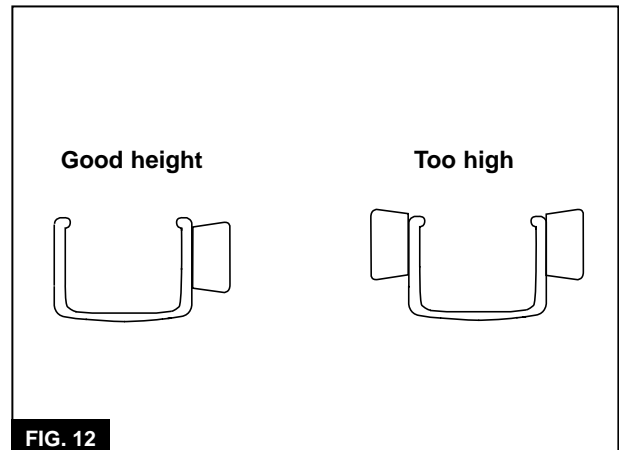

FIG. 12

Toe, vertical alignment, tangent, and height must be set whenever the brake pads, caliper arms, or wheels are replaced.

Toe and Vertical Alignment

Toe can be set by manually manipulating the pad or by using a spacer. Both methods are described below.

Manual Method

1. Loosen the pad mounting nut just enough so the pad can be manipulated by hand.
2. Adjust the brake cable so the face of the pad almost touches the rim.
3. Manually set the toe by pulling the leading edge of the pad (rear edge) away from the rim while pressing the trailing edge (front edge) to the rim.
4. Tighten the pad mounting nut enough to hold the pad in position.
5. Visually inspect the pad for vertical-angle alignment. If necessary, manipulate the pad so the pad face parallels the surface of the rim (**Figure 10**).

Spacer Method

1. Loosen the pad mounting nut just enough so the pad can be manipulated by hand.
2. Put a spacer between the leading edge of the pad (rear edge) and the rim.
3. Adjust the brake cable so the face of the trailing edge (front edge) of the pad touches the rim.
4. Tighten the pad mounting nut enough to hold the pad in position.

5. Visually inspect the pad for vertical-angle alignment. If necessary, manipulate the pad so the face of the pad parallels the rim (**Figure 10**).

Tangent Alignment

1. Look at each pad from the side, and note the position of the top of the pad relative to the rim. The distance from the top of the pad to the top of the rim should be the same at each end of the pad (**Figure 11**).

2. If one end of the pad is closer to the rim than the other, rotate the pad around the shoe stud to adjust tangent alignment.

Pad Height

1. Look at each pad from the side, and note where the pad engages the brake surface of the rim. (**Figure 12**).

2. To adjust the height, move the brake stud up or down in the caliper slot. Adjust height so the pad presses against the top of the rim without interfering with the tire. The top of the pad should be 1 mm (0.04 in.) below the top of the rim.

3. If pad height cannot be adjusted without affecting vertical alignment, correctly set the pad height.

4. Torque the pad mounting nut to the specification in Table 4.

5. If removed, reconnect the cable guide to the bracket in the left caliper arm.

CALIPER ARM

Removal

1. Squeeze the caliper arms together, and disconnect the cable guide from the bracket on the left caliper arm (A, **Figure 1**).

2. Loosen and unthread the caliper pivot bolt. (A, **Figure 4**)

3. Remove the caliper arm. Do not lose the washer that sits behind the caliper pivot bolt.

4. Inspect the caliper-mounting boss in the frame.

a. Be sure the threads of the caliper-mounting boss are clean.

b. The mating surface of the caliper-mounting boss should also be clean. Dress the area with emery cloth if necessary.

c. Inspect the caliper-mounting boss for cracks or other signs of wear.

Installation

1. Check that the washer is in place on the caliper-arm pivot bolt (**Figure 13**).



2. Apply Loctite 242 (blue) to the threads of the caliper pivot bolt.

3. Align the pin on the caliper bushing with the indexing hole in the caliper-mount boss (**Figure 14**).



4. Thread the caliper-pivot bolt into the caliper-mounting boss. As you tighten the pivot bolt, be sure the pin engages then indexing hole in the boss.
5. Torque the caliper pivot bolt to the specification in Table 4.
6. Align the brake pads as described in this chapter.
7. Squeeze the caliper arms together, and connect the cable guide to the bracket on the left caliper arm (A, **Figure 1**).
8. Secure the inner wire in the brake-caliper pinch mechanism by performing the following:
 - a. Feed the brake cable inner wire through the slot in the pinch mechanism.
 - b. Use the fourth-hand cable stretcher (Park Tool BT-2) to pull the inner wire until the combined clearance between each brake pad and the rim equals 2mm (0.08 in.).
 - c. Tighten the pinch bolt (B, **Figure 1**) to the specification in Table 4.
 - d. Crimp a new end cap onto the end of the inner wire.
9. Depress and release the brake lever several times, and check the caliper arm balance.
 - a. The brake pads should contact the rim at the same time when the brakes are applied.
 - b. The gap between each pad and the rim should equal 1 mm (0.04 in.) when the brake lever is released.

CAUTION

Do not set the caliper-arm spring tension too high.

- c. If necessary, balance the caliper arms by turning the spring-tension adjuster (B, **Figure 4**) on either arm.
10. Adjust the brake lever free play as described in this chapter.

MODULATOR BRAKES

The rear brakes on PE and SX models are equipped with modulator brakes. The spring-activated arms on these brakes rapidly apply-and-release the brakes to inhibit wheel lockup.

To adjust the brake cable free play and the brake pads on modulator brakes, follow the adjusting procedures described above for V-Brakes.

To adjust the modulation, use a 2 mm Allen wrench to turn the modulation adjuster (**Figure 15**) on each brake arm. Turning the adjuster clockwise decreases the amount of modulation. Turning the adjuster counterclockwise increases the amount of modulation. Be sure to set the modulation on each arm to the same level.



DISC BRAKE

Brake Pad Clearance Adjustment (PE and SX Models)

PE and SX models are equipped with a Diatech Spiral Stop Disc Brake on the front wheel. The following procedure describes the brake pad adjustment for this brake.

1. Remove the rubber cap from the adjuster.
2. Hold the adjuster (A, **Figure 16**) with an Allen wrench, and loosen the adjuster locknut (B, **Figure 16**).



3. Spin the wheel and turn the adjuster clockwise until the brake pads stop the wheel.
4. Back out the adjuster 1/2 turn (counterclockwise).

5. Hold the adjuster with the Allen wrench, and tighten the locknut (B, **Figure 16**) securely.
6. Set the pads by sharply apply the brakes four or five times.

NOTE:

A slight amount of pad scraping is normal, especially with new brakes or new brake pads.

7. Spin the wheel and check for brake pad/disc scraping. Repeat the adjustment procedure if scraping is noted.

Brake Pad Clearance Adjustment (LE Models)

An optional Diatech Twin Cam Disc Brake is available for LE models. The following procedure describes brake pad adjustment on this disc brake.

1. Hold the adjuster (A, **Figure 17**) with an Allen wrench, and loosen the adjuster locknut (B, **Figure 17**).
2. Spin the wheel and turn the adjuster clockwise until the brake pads barely scrape against the brake disc.
3. Back out the adjuster 1/2 turn (counterclockwise).

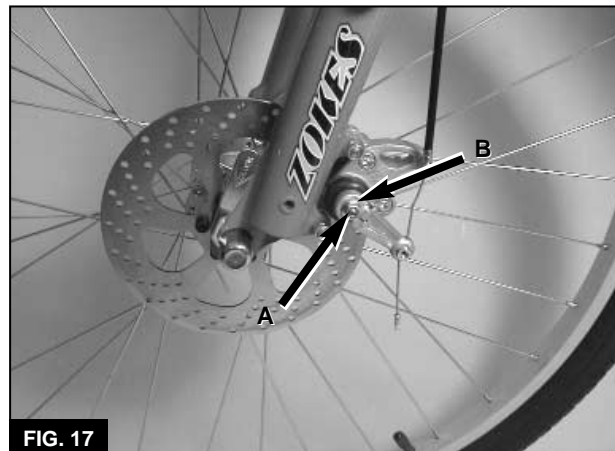
**FIG. 17**

4. Hold the adjuster with an Allen wrench, and tighten the locknut (B, **Figure 17**) securely.
5. Set the pads by sharply apply the brakes four or five times.

NOTE

A slight amount of pad scraping is normal, especially with new brakes or new brake pads.

6. Spin the wheel and check for brake pad/disc scraping. Repeat the adjustment procedure if scraping is noted.

Chapter Six

SHIFTER and DERAILLEUR

SHIFTER

Removal

1. Remove the shift cable from the S-hook (**Figure 1**) that holds the cable to the front brake cable.



FIG. 1



FIG. 2

2. Loosen the mounting screw in the mirror housing, and remove the mirror from the end of the handlebar (**Figure 2**).

3. Remove the handlebar grip from the left end of the handlebar. Do not lose the shim between the grip and the shifter housing.

4. Loosen the shifter clamp bolt, and slide the shifter housing from the handlebar (**Figure 3**). Guide the shifter cable around the headlight as you remove the shifter housing.

5. If you are not servicing the shifter or the cable, lay the shifter over the top tube. Secure it in place so it will remain out of the way. Do not severely bend or kink the cable.



FIG. 3

Installation

1. Slide the shifter housing onto the left end of the handlebar (**Figure 3**).

2. Gently route the shifter cable over and behind the headlight as you slide the shifter housing against the brake-lever body.

3. Slide the shim onto the handlebar. Install the handlebar grip so the grip end is flush with the handlebar end.
4. Slide the shifter body against the grip shim.
5. Rotate the shifter body so the adjusting barrel is below the brake lever. Tighten the shifter clamp bolt to the specification in Table 4.
6. Check the operation of the brake lever. Reposition the shifter body as necessary.
7. Secure the shift cable to the front brake cable with the S-hook (**Figure 1**). Be sure the rear brake cable is positioned behind the S-hook.
8. Fit the mirror housing into the handlebar end (**Figure 2**). Tighten the mirror mounting screw to the specification in Table 4.

SHIFTER CABLE

Removal

NOTE

Before removing the shifter cable, note how the cable is routed along the frame. The new cable will have to be routed along the same path.

1. Operate the shifter and move the chain to the outermost cog.
2. Remove the right side cover from the E-Bike®.
3. Note how the shifter cable is routed along the top tube and the right seat stay. The cable will have to be rerouted along the same path.
4. At the derailleur, remove the end cap (**A**, **Figure 4**) from the end of the inner wire.

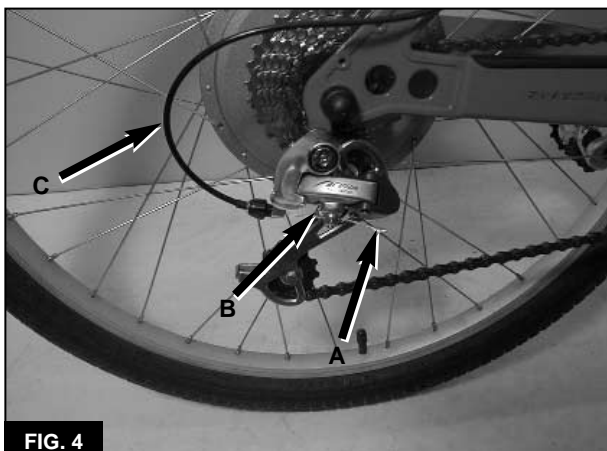

FIG. 4

5. Loosen the pinch-mechanism nut (**B**, **Figure 4**). Pull the shifter cable from the derailleur pinch mechanism and out of the barrel adjuster.

6. Slide the lower cable housing (**C**, **Figure 4**) off the inner wire. Do not lose the ferrule from either end of the lower cable housing.
7. Release the inner wire from the two housing stops on the right seat stay (**A**, **Figure 5**).
8. Slide the tube (**B**, **Figure 5**) that sits between the two housing stops off the inner wire.

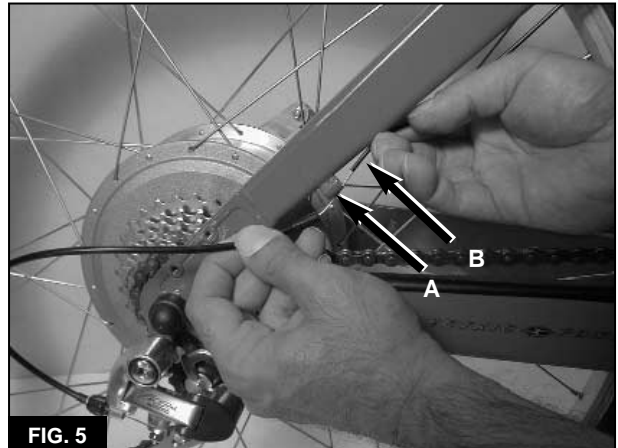

FIG. 5

9. Pull the shifter cable from the cable inlet in the right side cover.
10. Slide the upper cable housing from the inner wire (**Figure 6**). Do not lose the ferrule from either end of the upper cable housing.



FIG. 6

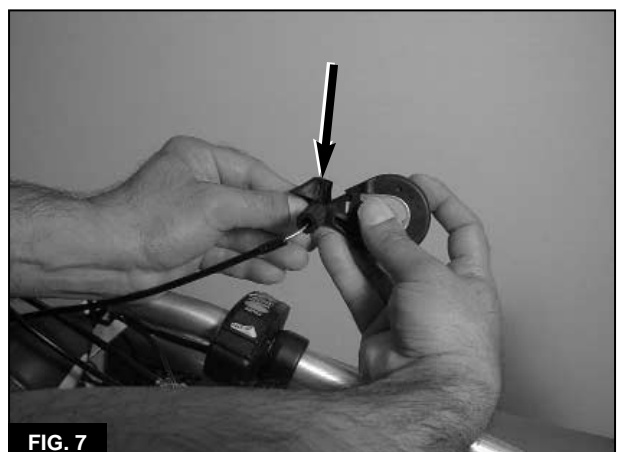

FIG. 7

11. Remove the shifter from the handlebar as described in this chapter.
12. Gently pry the cover plate from the inside face of the shifter housing (**Figure 7**).
13. Pull the twist unit from the shifter housing. Slide the shifter housing down the inner wire and remove it.
14. Push the inner wire into the twister unit until the barrel end of the inner wire emerges from the socket in the twister unit (**Figure 8**).
15. Pull the inner wire from the twister unit.



FIG. 8

NOTE

The shifter inner wire can be removed and replaced without removing the cable housings.

Installation

A fourth-hand tool (Park Tool BT-2) is required to perform this procedure

CAUTION

Do not use solvent to clean the shifter housing and twist unit. The solvent could attack the plastic in these parts.

1. Clean the shifter housing and twist unit with soap and water. Dry them thoroughly before proceeding.
2. Preset the derailleur adjustment screws before installing the cable.
 - a. Stand behind the E-Bike®, and check the position of the derailleur. The guide pulley should align with the outermost cog as shown in **Figure 9**.
 - b. If necessary, adjust the outward limit by turning the H-screw. Tighten the H-screw to adjust the guide pulley inward. Loosen the H-screw to adjust the derailleur outward.

- c. Use your hand to move the derailleur to its innermost position.
- d. Hold the derailleur against the stop and check the guide-pulley alignment.
- e. The guide pulley should align with the innermost cog as shown in **Figure 10**.
- f. If necessary, adjust the inward limit by turning the L-screw. Tighten the L-screw to move the derailleur outward. Loosen the L-screw to move the derailleur inward.

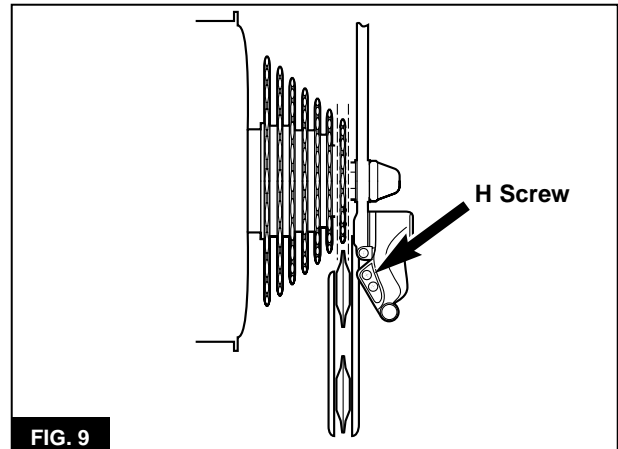

FIG. 9

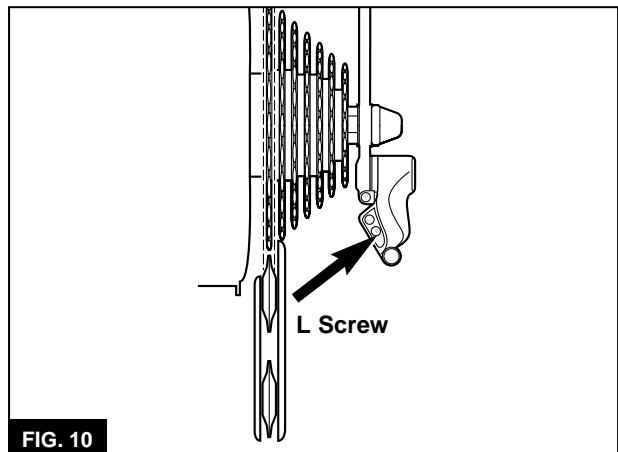

FIG. 10

CAUTION

Lubricate the shifter and cable with Grip Shift Jonnisnot grease or petroleum jelly. No other lubricant is suitable for the shifter.

3. Thoroughly lubricate the shifter-housing barrel, spring, cable groove, shifter-housing clip, and the twist unit with Grip Shift Jonnisnot grease or petroleum jelly.
4. Feed the free end of the inner wire through the socket in the twist unit until the barrel end of the wire is seated in the socket (**Figure 11**).



FIG. 11

5. Feed the inner wire along the cable groove (**Figure 12**) in the shifter housing and out through the barrel adjuster.



FIG. 12

6. Fit the twist unit into the shifter housing. Pull firmly on the inner wire while pressing the twist unit into the shifter housing. Be sure the end of the twist unit engages the clip in the shifter housing (**Figure 13**).



FIG. 13

7. Check that the cable is still seated in the groove in the shifter housing, and install the cover plate (**Figure 7**).

8. Check the operation of the shifter. Pull the inner wire while you operate the shifter. The inner wire should move in and out, and the shifter should click along its detents.

9. Slip the shifter onto the handlebar.

10. Lubricate the upper cable housing with oil, and slide the inner wire through the upper cable housing. Be sure the inner wire passes through the ferrule at each end of the cable. Slide the upper cable along the inner wire until the ferrule is seated inside the barrel adjuster at the shifter housing.

11. Route the shift cable around the headlight, through the cable inlet in the right side cover, and along the top tube.

12. Slide the tube (**B, Figure 5**) over the free end of the inner wire and up to the cable housing.

13. Fit the inner wire through the two housing stops on the right seat stay (**A, Figure 5**). Be sure the ferrule from the upper cable housing fits into the upper housing stop and that the tube is secure between both housing stops.

14. Lubricate the lower cable housing with oil. Be sure a ferrule is in place on each end of the lower cable housing, and install the inner wire through the lower cable housing (**C, Figure 4**). Fit the upper ferrule into the seat in the lower housing stop.

15. Feed the inner wire through the barrel adjuster on the derailleur and through the pinch mechanism. The lower-housing ferrule should be seated in the barrel adjuster, and the inner wire should be properly routed through the pinch mechanism.

16. Finger tighten the pinch-mechanism nut so the inner wire is held securely in the pinch-plate groove, and check the following:

- a. The inner wire should follow the groove in the pinch plate.
- b. When looking directly at the pinch mechanism stud, the tab on the pinch plate should be on the outboard side of the inner wire (**Figure 14**).

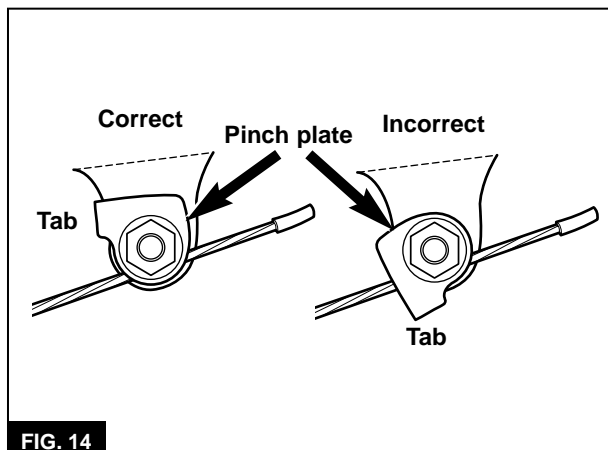

FIG. 14

17. Loosen the pinch-mechanism nut, and use the fourth-hand tool to pull the slack from the inner wire.

18. Torque the pinch-mechanism nut (B, **Figure 4**) to the specification in Table 4. Check that the inner cable is still contained within the groove in the pinch-mechanism plate.

19. Fit an end cap (A, **Figure 4**) over the end of the inner wire, and crimp it onto the wire.

20. Install the shifter onto the left handlebar as described in this chapter.

21. Adjust the derailleur as described in this chapter.

22. Set the cable tension as described in this chapter.

DERAILLEUR

Derailleur Lubrication

Apply lubricant to the following points on the derailleur. See **Figure 15**.

1. Each edge of the pulley-wheel dust cap.
2. Both ends of each pivot on the parallelogram.
3. Threads of the mounting bolt.
4. Threads of the barrel adjuster.
5. Threads of the pinch-mechanism.

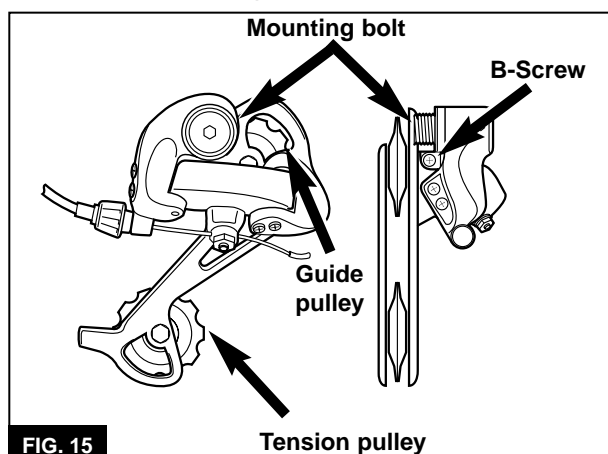

FIG. 15

Derailleur Adjustment

Three screws, the H-, L-, and B-screws, are used to adjust the derailleur. The H-screw sets the outward limit of the derailleur's movement. The L-screw sets its inward limit. The B-screw adjusts the distance between the bottom of the cogset and the derailleur's guide pulley.

A fourth-hand tool (Park Tool BT-2) is required to perform this procedure

1. Check the cable attachment to the derailleur pinch mechanism.

a. Inspect the position of the inner wire in the pinch-mechanism. The inner wire should follow the groove in the pinch plate, and the tab on the pinch plate should be on the outboard side of the cable when you look directly at the pinch-mechanism stud (**Figure 14**).

b. Loosen the pinch-mechanism nut. Use the forth-tool to pull the slack from the inner wire.

c. Torque the pinch-mechanism nut to the specification in Table 4.

d. Check that the inner cable is still contained within the groove in the pinch-mechanism plate.

2. Set the derailleur as close as possible to the cogset by performing the following.

a. Shift the chain to the innermost cog.

b. Completely loosen the B-screw.

c. Back-pedal, and check for bouncing at the guide pulley (**Figure 16**). The B-screw is too loose if bouncing is noticed.

d. Tighten the B-screw one turn, and repeat the bounce check.

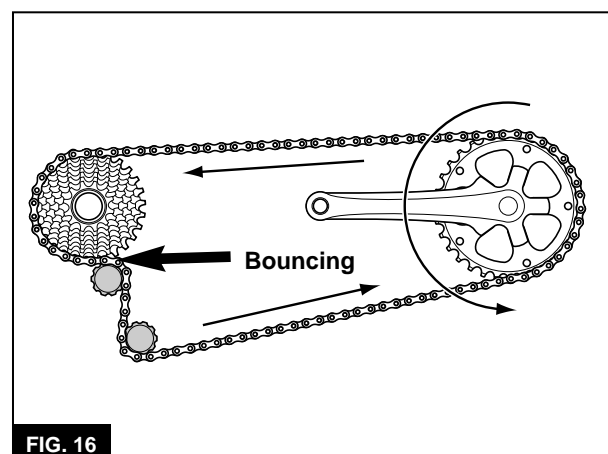

FIG. 16

3. Set the derailleur's outward limit by performing the following.
 - a. Shift the derailleur so the chain is on the outermost cog.
 - b. Stand behind the E-Bike®, and check the position of the derailleur. The guide pulley should align with the outermost cog as shown in **Figure 9**.
 - c. If necessary, adjust the outward limit by turning the H-screw. Tighten the H-screw to adjust the guide pulley inward. Loosen the H-screw to adjust the derailleur outward.
4. Set the derailleur's inward limit by performing the following.
 - a. Shift the derailleur so the chain rests on the innermost cog.
 - b. Stand behind the E-Bike®, and check the position of the derailleur. The guide pulley should align with the innermost cog as shown in **Figure 10**.
 - c. If necessary, adjust the inward limit by turning the L-screw. Tighten the L-screw to move the derailleur outward. Loosen the L-screw to move the derailleur inward.

Setting Cable Tension

A fourth-hand tool (Park Tool BT-2) is required to perform this procedure.

1. Loosen the nut on the derailleur pinch mechanism.
2. Turn the derailleur barrel adjuster to its full-in position, and then back out the adjuster three full turns.

3. Turn the shifter barrel adjuster to its fully-in position, and then back out the adjuster one full turn.

NOTE

Do not pull the inner wire so much that the derailleur begins to move.

4. Use a fourth-hand tool to pull the slack out of the inner wire.
5. Torque the pinch-mechanism nut to the specification in Table 4. Check that the inner wire is still positioned within the pinch-mechanism groove.

Derailleur Installation

1. Lubricate the derailleur as described above.
2. Align the mounting bolt with the hole in the hanger.
3. Rotate the derailleur clockwise so the stop tab on the derailleur mounting plate (or the end of the B-screw) is forward (clockwise) of the stop tab on the derailleur hanger.
4. Thread the mounting bolt into the hanger but do not completely secure the bolt at this time.
5. Rotate the derailleur counterclockwise until the derailleur stop tab presses against the stop tab on the hanger.
6. Tight the mounting bolt to the torque specification in Table 4.

Chapter Seven

CHAIN and CRANKSET

CHAIN

Inspection

The chain inspection tool (Part Tool CC-2C) is required for this service.

1. Install the chain inspection tool onto the chain according to the manufacturer's instructions. Be sure both of the tool's pegs are inside a chain link.
2. Rotate the tool's dial so the pegs press against the inside of the chain rollers.
3. Read the number opposite the V-notch on the dial.
 - a. 0-1 indicates the chain is in good condition.
 - b. 1-2 indicates the chain is moderately worn.
 - c. 2-3 indicates the chain is approaching the wear limit.
 - d. 3 or more indicates the chain is worn beyond the wear limit.

Checking Chain Length

1. Secure the E-Bike® in the stand so the E-Bike® is at an angle it would be in if it were upright on level ground.
2. Shift the derailleur so the chain rides on the outermost cog.
3. Examine angle formed by a line through the center of the two derailleur pulleys and the ground or floor.
 - a. The chain length is perfect if this line is perpendicular (90 degrees) to the ground (**Figure 1**).

- b. Chain length is acceptable if the tension pulley is 1.75 in. or less forward or rearward of the guide pulley.

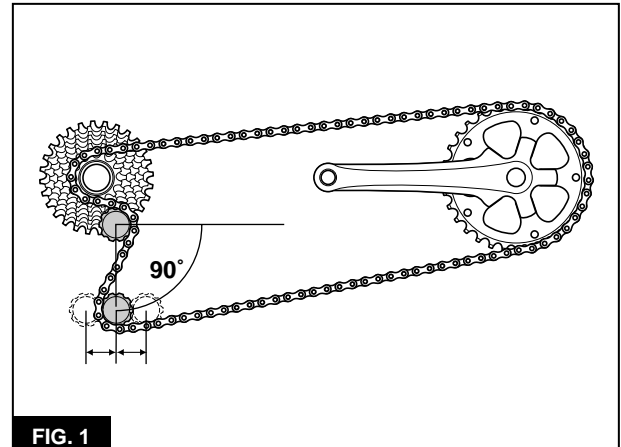

4. Examine the chain.
 - a. The chain is too long if it sags in the upper chain run as shown in **Figure 2**.
 - b. The chain is too long if the chain contacts itself or any part of the derailleur after the chain leaves the tensioner pulley (**Figure 3**).

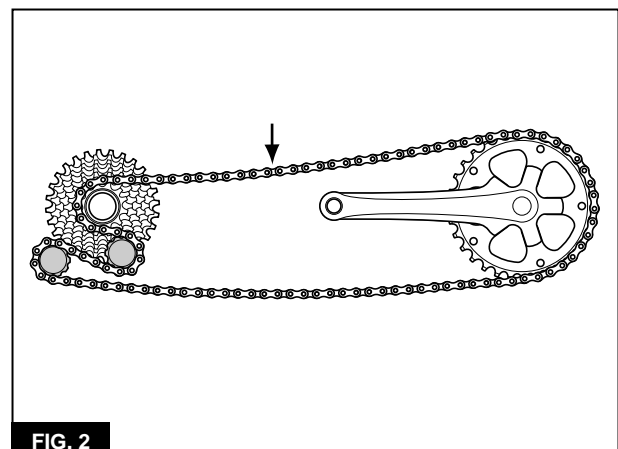

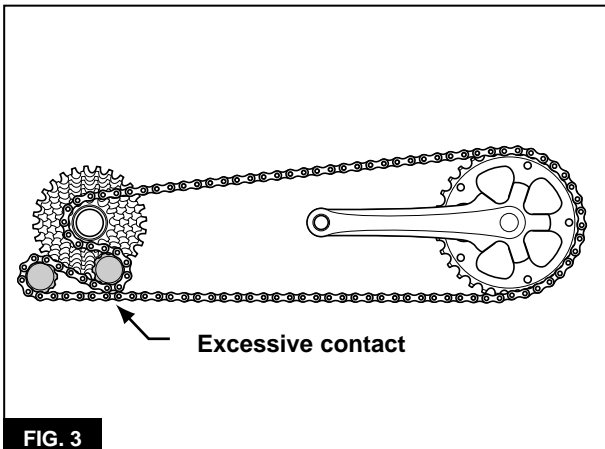

5. Shift the derailleur so the chain rides on the innermost cog.
6. Examine the chain as it passes through the derailleur.
 - a. If the chain passes through the derailleur without bending twice, the chain is too short. See **Figure 4**.

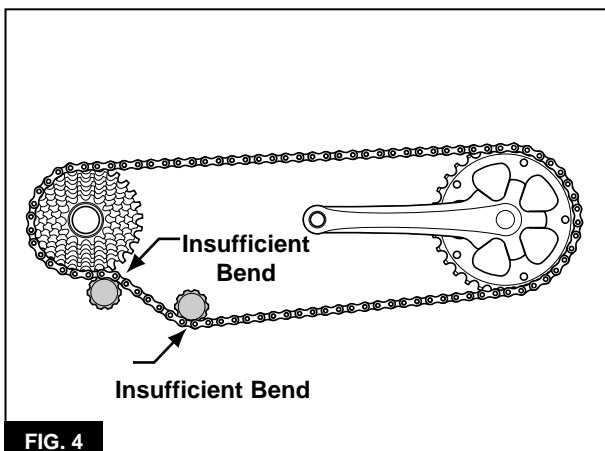

Removal

A chain breaker (Park CT-3) is required for removing and installing the chain.

1. Shift the chain to the outermost cog.
2. Inspect the driving pin of the chain breaker. Replace the tool if the pin is not straight.

CAUTION

Some chain breakers have two cradles. The cradle furthest from the guide pin is for removing/installing the chain. The cradle closest to the guide pin is for adjusting a tight link. Be sure to use the correct cradle for the task.

3. Fit the chain breaker onto a link in the chain's lower run. Be sure the chain rollers are fully seated in the tool's cradle and that the driving pin is centered on the chain rivet.
4. Turn the tool handle until the driving pin just touches the rivet.

NOTE

*The rivet should be pressed the minimum distance necessary to separate the chain and no more. Do not drive the rivet completely from the inner plate on the inboard side of the chain. The chain can be separated once the rivet extends 0.5 to 1.0 mm into the inside of the inner chain plate. See **Figure 5**.*

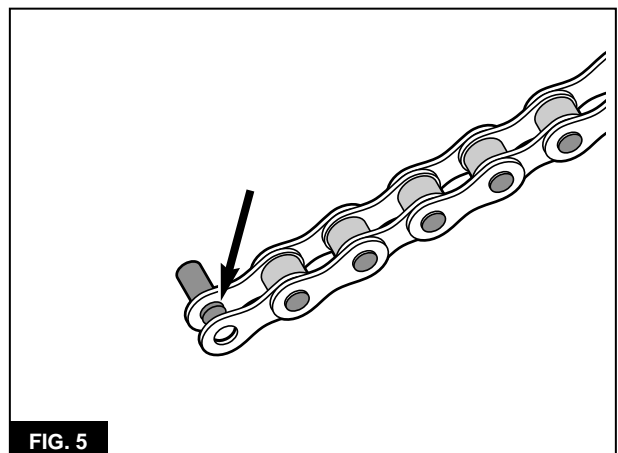

5. Turn the tool handle five full turns, but no more.
6. Remove the tool from the chain.
7. Flex the chain laterally, and separate the chain.
8. Remove the chain from the E-Bike®.

Cleaning

1. Immerse the chain in solvent.
2. Use a stiff brush to clean the both sides of the chain.
3. Use the brush carefully when cleaning the rollers. Take special care to see that the rollers are completely clean.
4. Rinse the chain in clean solvent.
5. Dry the chain with compressed air.

Installation

1. If necessary, move the derailleur so it is under the outermost cog.

2. Take the non-riveted end of the chain and feed it under and around the rear of the tension pulley on the derailleur. Following the derailleur cage, route the chain up the front and over the top of the guide pulley. Once the chain emerges from the derailleur cage, route it under and around the outermost cog.
3. Next route the chain around the chainring.
4. Move the chain so the two free ends meet at the middle of the lower chain run.
5. Join the two ends together by slipping the end of the inner plate under the rivet protruding inward from the outer plate.
6. Fit the chain tool onto the chain. Pay attention to the following:
 - a. If the tool has two cradles, fit the chain over the cradle furthest away from the tool handle.
 - b. Be sure the rollers are fully seated on the tool cradle.
 - c. Turn the tool handle so the drive pin is centered on the rivet.
 - d. Check that the side plates are properly aligned.

7. Turn the tool handle, and drive the rivet through the chain until the rivet is centered within the link. The rivet is properly installed when an equal amount of rivet protrudes from the outside of each outer side plate (**Figure 6**).

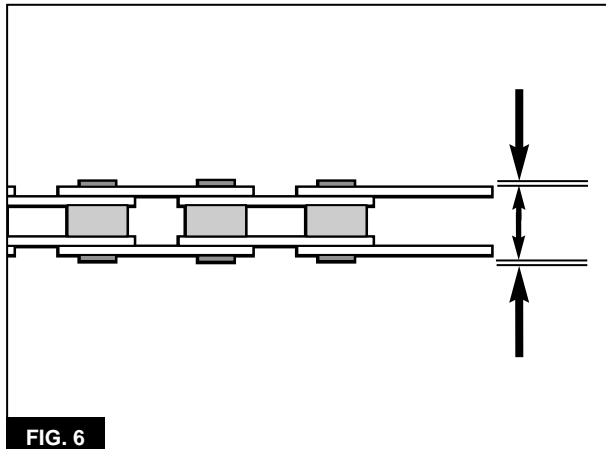

FIG. 6

Lubrication

NOTE

Do not apply excessive amounts of oil to the chain. Excessive lubrication promotes the accumulation of dirt, which accelerates chain wear.

CAUTION

Use oil designed for bicycles. Automotive and household oils are unsuitable for the E-Bike® chain.

1. Oil the contact areas between the inner and outer side plates on each link (**A, Figure 7**) as well as the contact areas between the inner side plates and each end of the rollers (**B, Figure 7**).

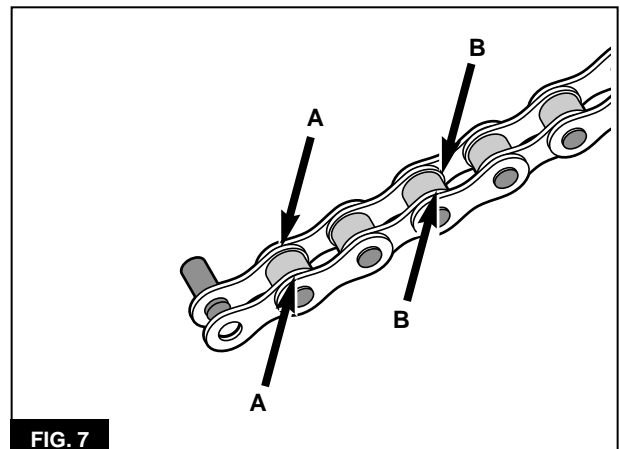

FIG. 7

2. If the chain is installed on the E-Bike®, back pedal for 30 seconds. If the chain is not installed, wiggle the chain for 30 seconds. This helps the lubricant penetrate the crevices in the chain.
3. Use a clean cloth to wipe excess lubricant from the chain.

CRANK ARM

Removal

A cotterless crank wrench (Park Tool CCW-14R) is required for this service.

1. If the pedal will also be serviced, remove the pedal from the crank arm.
2. Measure the clearance between the outside face of the chainring and the right chain stay.
 - a. Check the clearance on the rear side of the chainring.
 - b. Check the chainring clearance at several places, and write down the smallest value.
 - c. Compare this value to the specification in Table 1.
 - d. The chainring and/or chain stay is damaged if the measurement is not within the specified range.
3. Loosen and remove the crank-arm mounting bolt (**Figure 8**).



4. Inspect the position of the spindle end. The end of the spindle should be recessed within the crank-arm square hole. If the spindle end is flush with the surface of the crank-arm square hole, the crank arm is excessively worn and must be replaced.

5. If you intend to reinstall the crank arm, mark one corner of the spindle end and a corresponding mark on the crank arm (**Figure 9**). The marks will facilitate assembly.

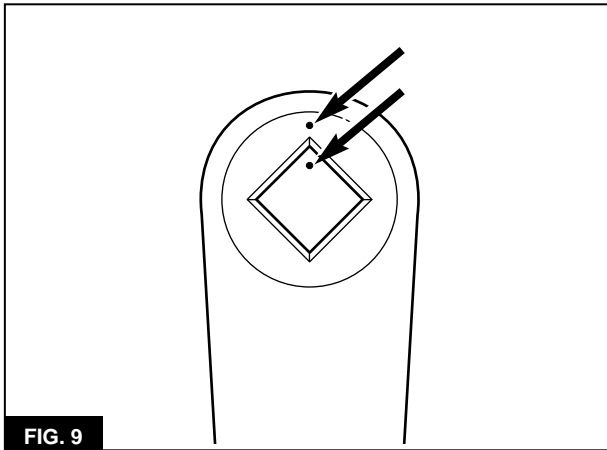

6. Carefully thread the crank wrench onto the crank arm. Finger tighten the wrench until it bottoms in the crank arm, and then snug it in place with an adjustable wrench. When properly installed, you should be able to turn the crank wrench handle with your fingers (**Figure 10**).

CAUTION

If the crank wrench body starts to rotate or if the body appears to pull from the crank arm when you tighten the crank wrench, remove the crank wrench body and identify the problem. The crank wrench threads may be damaged. Correct the problem before proceeding.



7. Turn the crank wrench handle clockwise, and press the crank arm off the spindle.

8. If you are removing the right arm, remove the chainring from the chain, and suspend the chain from the frame with a bungee cord.

Inspection

1. Inspect the spindle flats for signs of a loose or worn crank arm. The crank-arm marks on the spindle flats should not extend along the entire surface of the flat (**Figure 11**). If they do, the crank arm is worn and must be replaced.

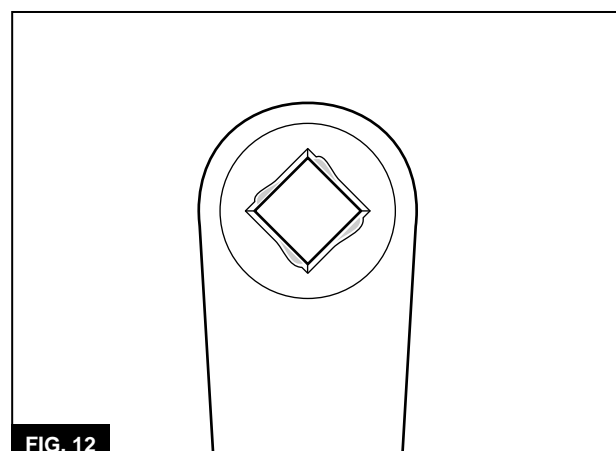
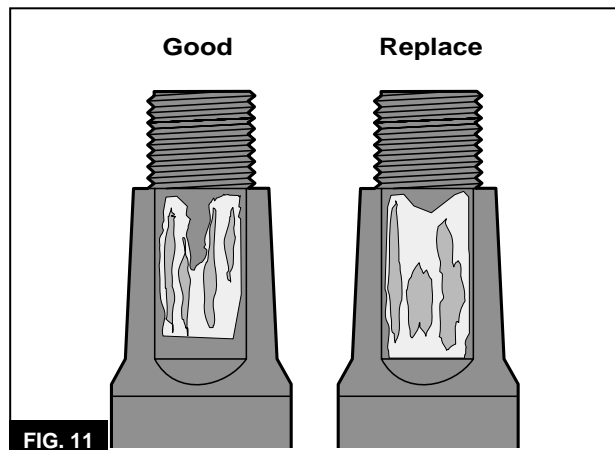

2. Inspect the square hole in the crank arm (**Figure 12**). The flats of the hole should be straight and even. Replace the crank arm if its square hole shows signs of wear or damage.
3. Inspect the crank arm for cracks or other signs of wear. Pay particular attention to the area around the mounting holes at either end of the crank arm. Replace the crank arm if it is worn.
4. Inspect the spider arms (the crank-arm spokes) on the right crank arm. Replace the crank arm if any spider arm is cracked or shows other signs of damage.

Installation

When installing both crank arms, install the right crank arm first, and then install the left crank arm so it is oriented 180° from the right arm.

1. If you are installing a new right crank arm or a new chainring, check chainring wobble as described below.
2. Clean the flats of the spindle with acetone or alcohol.
- 3A. If you are reinstalling the old crank arm, fit the crank arm onto the spindle so the mark you made on the crank arm aligns with the mark on the spindle end. (**Figure 9**) Tap the crank arm onto the spindle with a plastic mallet.
- 3B. If installing a new right crank arm and/or new chainring, perform the following:
 - a. Rotate the spindle so the reference mark (from the chainring wobble test) is at the position that produced the least amount of wobble.
 - b. Fit the chainring into the chain.
 - c. Rotate the derailleur forward, and fit the crank arm onto the spindle so that the arm is at 6 o'clock.
 - d. Tap the crank arm onto the spindle with a plastic mallet.
4. Apply grease to the crank-arm mounting bolt.
5. Install the crank-arm mounting bolt, and torque it to the specification in Table 4.
6. Repeat for the left crank arm if necessary. Be sure the left crank arm is 180° opposite the right crank arm.

CHAINRING

Removal

1. Remove the right crank arm as described

in this chapter.

2. Examine the inboard side of the crank-arm/chainring. Note that the chainring is mounted so the cutout with the tab aligns with the crank arm (**Figure 13**). The chainring will have to be mounted in this position during installation.

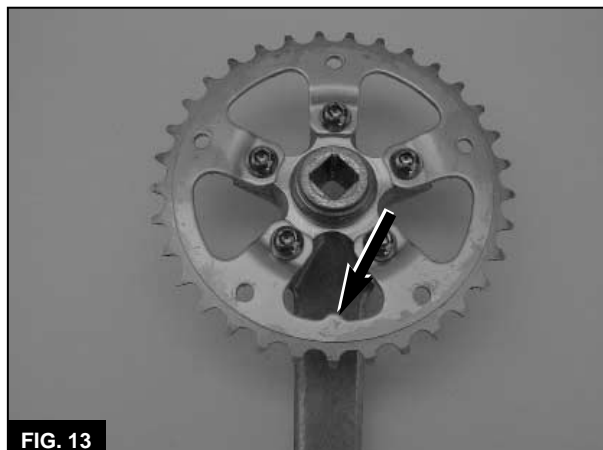

FIG. 13

3. Remove the five chainring bolts, and remove the chainring from the crank arm.

Installation

1. Fit the chainring onto the spider (the crank-arm spokes) so the chainring mounting holes align with the threaded hole on the spider.
2. Be sure the cutout with the tab (**Figure 13**) aligns with the crank arm.
3. Apply oil to the threads of the chainring bolts.
4. Finger tighten all five chainring bolts, and then torque the bolts to the specification in Table 4.

Chainring Wobble Check

When installing a new right crank arm or reinstalling a right crank arm with a new chainring, you must install the crank arm in the position that produces the least amount of chainring wobble. Perform the following to determine that position.

1. Place a reference mark in one corner of the end of right spindle.
2. Rotate the spindle so the reference mark is at 12 o'clock.
3. Fit the right crank arm onto the spindle so the arm points to 6 o'clock.
4. Strike the arm with a rubber mallet so the arm is securely seated on the spindle.



FIG. 14

5. Set your hand against the frame down tube with the end of your forefinger touching the inside of the chainring (**Figure 14**).
6. Rotate the crank arm and note the amount of wobble in the chainring.
7. Remove the crank arm by striking the arm with the rubber mallet.
8. Rotate the spindle so the reference mark is now at 3 o'clock, and repeat steps 3-7.
9. Rotate the spindle so the reference mark is at 6 o'clock, and repeat steps 3-7.
10. Rotate the spindle so the reference mark is at 9 o'clock, and repeat steps 3-7.
11. Note the position that produces the least amount of chainring wobble. Install the crank arm with the reference mark in that position.

PEDAL

The pedal on the right side has right-hand threads. The pedal on the left side has left-hand threads. Keep this in mind when removing and installing pedals onto the crank arms.

Removal

1. Rotate the crank so the arm with the pedal being removed points towards the rear of the E-Bike®.
2. Place a wrench onto the pedal flats so the shaft of the wrench is horizontal and pointing forward.
3. Break the pedal loose.
4. While facing the crank, hold the pedal with one hand and the wrench with the other. Rotate the pedal forward (normal pedaling motion) and remove the pedal.
5. Repeat this procedure for the opposite pedal.

Installation

1. Inspect the threads of the pedal stud. Install the pedal with the right-hand thread onto the right side of the E-Bike®. Install the pedal with the left-hand threads onto the left side.
2. Grease the threads of the pedal stud.
3. Thread the left pedal onto the left crank arm. Tighten the pedal stud as far as possible by hand.
4. Face the pedal, and fit a wrench onto the pedal flats. Hold the pedal with one hand and hold the wrench with the other (**Figure 15**).



FIG. 15

5. Rotate the crank arm rearward (opposite the direction of normal pedal rotation) until the pedal is snug.
6. Tighten the pedal to the torque specification in Table 4.

CAUTION

Metal burrs are often created when the pedal is tightened against the crank arm. Use a rag to wipe up excess grease so you will not have to deburr your finger.

7. Use a rag to wipe excess grease from the crank arm.
8. Repeat this procedure for the right pedal.

BOTTOM-BRACKET CARTRIDGE

The E-Bike® uses a Chinhaur CH52-73 bottom-bracket cartridge. This cartridge threads into the right side of the bottom bracket. Its adapter ring threads into the left side of the bottom bracket.

The adapter ring on this cartridge has standard right-hand threads. The main body, however, has left-hand threads.

A bottom-bracket-cartridge tool (Park Tool BBT-2) is required for removing and installing the bottom-bracket cartridge.

Removal

1. Remove both crank arms.
2. Remove the left bottom-bracket cover (**Figure 16**).



FIG. 16

3. Install the bottom-bracket cartridge tool onto the adapter ring, and remove the ring from the left side of the bottom-bracket shell (**Figure 17**).

NOTE

The main body of the cartridge has left-hand threads. Turn the cartridge clockwise to remove it.

4. Install the bottom-bracket cartridge tool onto the main body of the cartridge, and remove the cartridge from the right side of the bottom bracket.



FIG. 17

Installation

NOTE

The bottom-bracket cartridge has very fine threads that are easily damaged. Check the threads in the bottom-bracket shell before installation. Dress or tap the threads as necessary.

1. Apply grease to the threads of the cartridge main body.

NOTE

The main body uses left-hand threads.

2. Carefully thread the cartridge into the right side of the bottom-bracket shell. Turn the main body counterclockwise until the cartridge is snug in the bottom-bracket shell.
3. Apply grease to the threads of the adapter ring.
4. Carefully thread the adapter ring into the left side of the bottom-bracket shell.
5. Fit the bottom-bracket-cartridge tool onto the adapter ring, and torque the ring to the specification in Table 4 (**Figure 17**).
6. Install the left bottom-bracket cover (**Figure 16**). Apply Loctite (red) to the threads of the bottom-bracket-cover screws, and torque the screws the specification in Table 4.

Chapter Eight

ELECTRICAL

CONNECTOR IDENTIFICATION

All electrical components in the E-Bike® connect to the controller, which is mounted between the side covers. Refer to **Figure 1**.

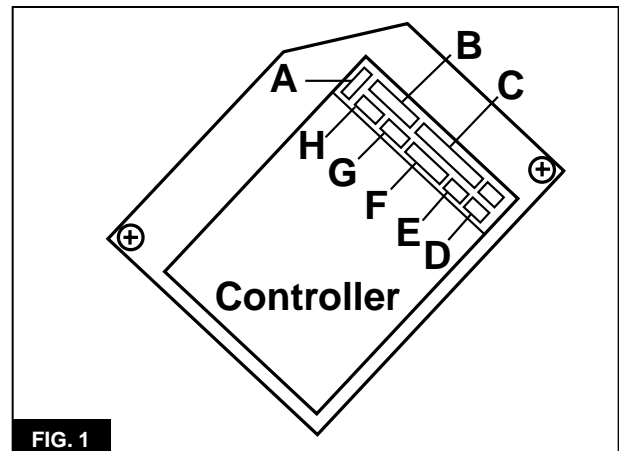

FIG. 1

Controller Board Connectors

Reference Number	Component/Function	Connector Type
A	5 amp fuse	
B	Accessory control (left side)	6-pin
C	Throttle control (right side)	7-pin
D	Brake sensor, right	2-pin
E	Brake sensor, left	2-pin
F	Taillight	4-pin
G	Horn (1 red and 1 black wire)	3-pin
H	Headlight (1 white and 1 black wire)	3-pin

RIGHT SIDE COVER

Removal

1. Open the door to the battery compartment.
2. Remove the three rubber plugs from the right side cover holes. Note that the small plug goes in the lower hole.
3. Remove the three side cover screws. The screw from the lower hole is smaller than the two upper screws. It will have to be reinstalled in the same location.
4. Lift the side cover from the E-Bike®.

5. If necessary, remove the cable inlet cover (A, **Figure 2**) from the left side cover. Pull the cable inlet cover forward and around the head tube until the tabs clear the left side cover .

Installation

1. If removed, install the cable inlet cover into the left side cover. Slide the tabs of the cover (A, **Figure 2**) onto the tongues of the side cover. Gently push cable inlet cover so it follows the side-cover contour around the head tube and rests in place in the left side cover.

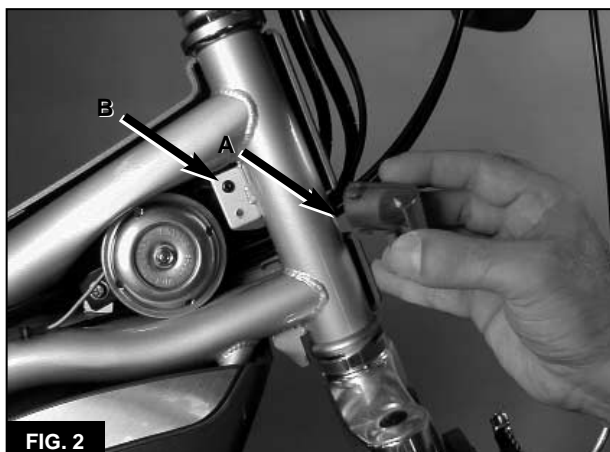

2. Fit the right side cover into place on the E-Bike®. Be sure no cables or wires are pinched between the side cover and the frame.
3. Apply Loctite (242) to the threads of the side cover mounting screws.
4. Install the screws. Be sure the short screw is installed in the lower hole. Torque the side cover mounting screws to the specification in Table 4.
5. Close and secure the battery compartment door.

LEFT SIDE COVER

Removal

1. Be sure the power knob is OFF, and remove the battery pack from the battery compartment.
2. Remove the right side cover from the E-Bike®.
3. Remove the cable inlet cover from the left side cover.
4. Remove the three battery-compartment screws (**Figure 3**) at the front of the battery compartment.



5. Remove the three left-side-cover screws. One is located behind the steering head (**B**, **Figure 2**), one is above the controller (**A**, **Figure 4**), and the third is toward the rear of the side cover (**B**, **Figure 4**).

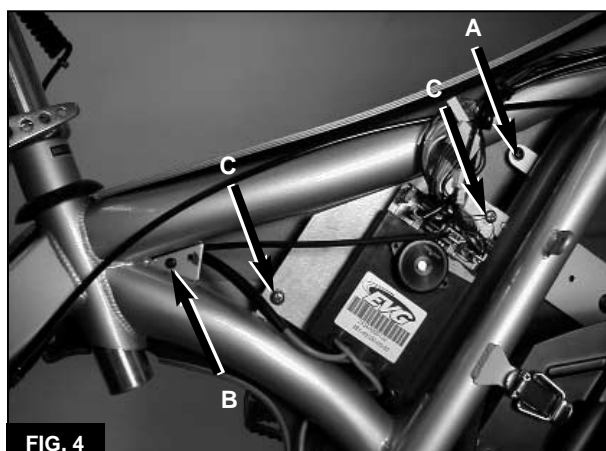

6. Carefully, pivot the right side cover away from the E-Bike® until the battery-compartment passes between the front wheel and forward down tube.
 - 7A. If you do not need to completely remove the left side cover from the E-Bike®, use a wire or bungee cord to suspend the side cover from the seat.
 - 7B. If the side cover must be completely removed, perform the following:
 - a. Squeeze the arms of the rear-brake caliper together, and disconnect the rear-brake cable guide from the bracket on the left caliper arm (**A**, **Figure 5**).
 - b. Loosen the brake-cable pinch bolt (**B**, **Figure 5**), and release the inner cable end from the pinch mechanism.
 - c. Carefully pull the brake cable from the rear port in the left side cover.

Installation

1. If removed, route the rear brake cable through the rear inlet in the left side cover.
2. Pivot the side cover into place. Carefully fit the battery compartment door between the front wheel and the forward down tube, and fit the side cover onto the left side of the E-Bike®. Be sure all electrical wires and cables fit into the cable inlet at the front of the left side cover.
3. Install the three battery-compartment screws (**Figure 3**) finger tight.
4. Apply Loctite 242 (blue) to the threads of

each left-side-cover mounting screw, and install each screw finger tight. See (B, **Figure 2** and A & B, **Figure 4**) along with the washer.

5. Torque the three side-cover mounting screws and the three battery-compartment screws to the specifications in Table 4.

6. If the brake cable was disconnected from the rear brake, perform the following:

- a. Feed the end of the brake cable inner wire through the pinch mechanism.
- b. Tighten the brake-caliper pinch bolt (B, **Figure 5**) to the specification in Table 4.
- c. Squeeze the arms of the rear-brake caliper together, and connect the cable guide to the bracket on the left caliper arm (A, **Figure 5**).
- d. If necessary, adjust the brakes.

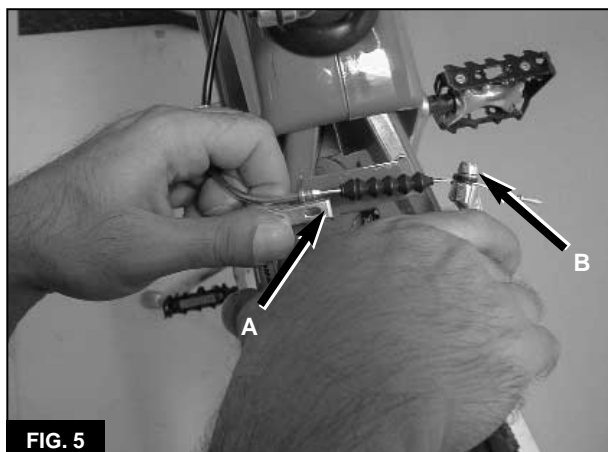

CONTROLLER

Removal

1. Be sure the power knob is OFF, and remove the battery pack from the battery compartment.
2. Turn the power knob to ON for five seconds to drain the capacitor in the controller.
3. Remove the right side cover from the E-Bike®.

NOTE

The horn (G, **Figure 1**) and headlight connectors (H, **Figure 1**) are identical. Either can be plugged into the other's terminals on the controller board. Label each connector before removal so it can be easily identified during assembly. If the headlight or horn connector are attached to the wrong terminal, the devices will not operate.

4. Disconnect connectors B, C, D, E, F, G, and H from the controller board. See **Figure 1**.

5. Remove the two mounting screws (A, **Figure 6**) and lift the terminal block (B, **Figure 6**) from the frame.

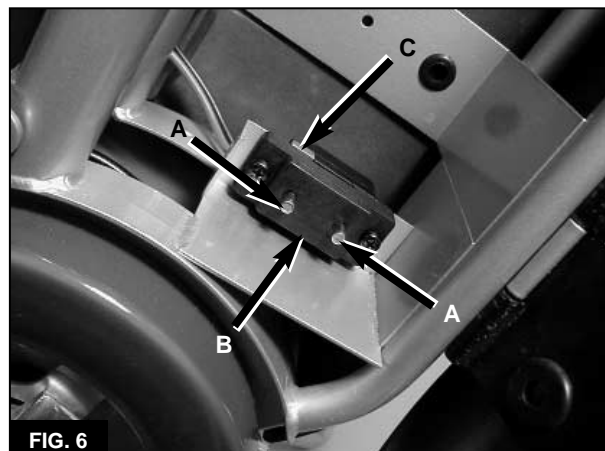

CAUTION

The red power lead connects to the left post in the terminal block. This terminal is identified by a red sticker (C, **Figure 6**) above the left terminal post. If this sticker has worn away, place a piece of tape above this post before removing the power leads. The leads must be connected to the correct posts during assembly.

6. Remove the terminal screw, and disconnect the black power lead (A, **Figure 7**) from its post on the terminal block. Disconnect the red power lead (B, **Figure 7**) from its terminal post.

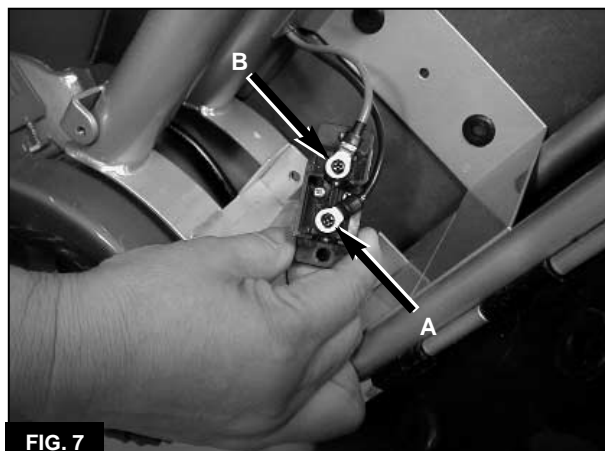

7. Remove the rear (B, **Figure 4**) and the lower left-side-cover screws.

8. Clip the cable tie on the QR connector, and disconnect the quick-release connector (**Figure 8**) as described below in this chapter.

9. Carefully remove the controller lead from the cable retainer on the left seat stay (**Figure 9**).

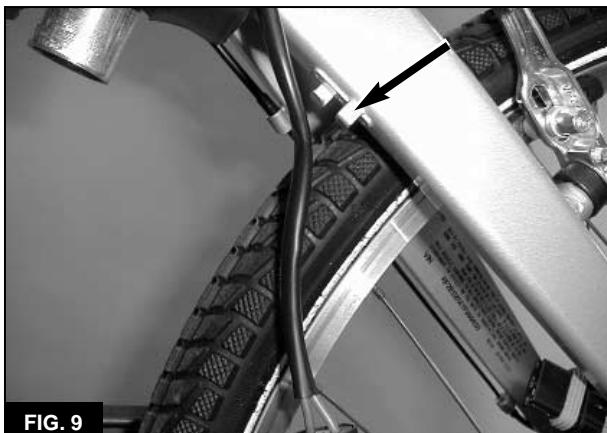

10. Gently pull the left side cover away from the frame, and pull the controller half of the QR connector between the frame and side cover. See **Figure 10**.



11. Remove the two controller-plate mounting screws (C, **Figure 4**), and remove the controller assembly from the E-Bike®.

Installation

1. Fit the controller assembly into place in the E-Bike®, and install the two controller-plate mounting screws (C, **Figure 4**). Tighten the screws securely.

2. Gently pull the rear of the left side cover away from the frame and feed the controller half of the QR connector between the frame and side cover. See **Figure 10**. Be sure the controller lead is not pinched between the side cover and the left seat stay.

3. Route the controller lead down the seat stay and secure the lead in the cable retainer (**Figure 9**) on the stay.

4. Connect the halves of the QR connector together, and snap the lock closed. Use a new cable tie to secure the connector to the seat stay. Be sure the QR connector wires are secured in the lower and upper retainers (**Figure 9**) on the seat stay. The wires must be clear of the wheel.

5. Gently pull the left side cover from the frame, and route the power leads between the side cover and the frame (**Figure 11**).

6. Secure each power lead onto its post on the terminal block. Be sure the red power lead (B, **Figure 7**) is connected to the left post, the one you marked during disassembly.

7. Install the terminal block (B, **Figure 6**) onto the frame, and secure it in place with the two mounting screws (A, **Figure 6**). Apply Loctite 242 (blue) to the threads of each terminal block mounting screw, and torque the screws to the specification in Table 4.

8. Reconnect the connectors to the controller. See **Figure 1**. Be sure the horn connector (G, **Figure 1**) and the headlight connector (H, **Figure 1**) are each connected to the correct terminals on the controller.

9. Reinstall the side covers as described in this chapter.

QUICK-RELEASE (QR) CONNECTOR

The QR connector is the electrical connection where the motor connects to the controller.

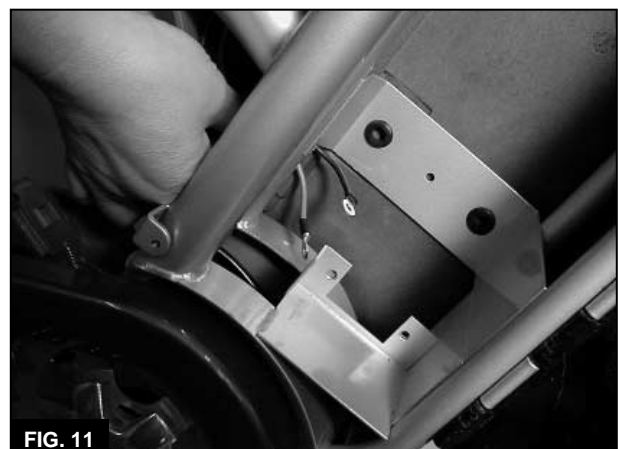

This self-sealing connector (A, **Figure 12**) mounted on the inside of the left seat stay.

Disconnecting

1. Clip the cable tie (B, **Figure 12**) that secures the QR connector to the left seat stay.

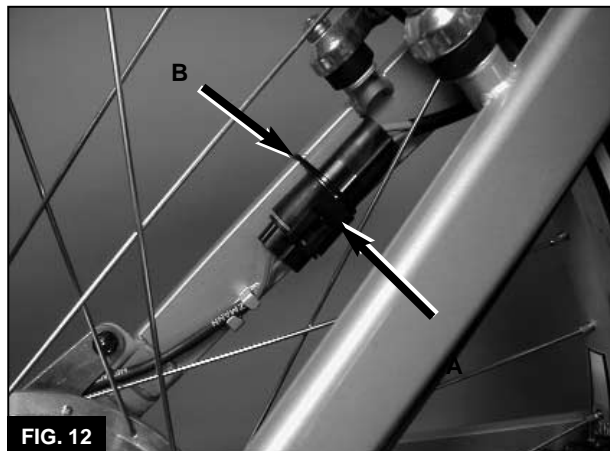

2. Unlatch the lock on the QR connector.
3. Disconnect the QR connector by pulling apart the connector halves. (**Figure 8**). Only pull the two parts of the connector housing. Do not pull the electrical leads. A wire could be disconnected from its terminal in the connector if you pull the leads.

Connecting

1. Be sure the QR connector wires are secured in the lower and upper retainers (**Figure 9**) on the seat stay. The wires must be clear of the wheel.
2. Press the halves of the connector together until the connector is closed and completely sealed.
3. Press the lock toward the QR connector to be sure it is closed.
4. Secure the connector to the left seat stay with a new cable tie.

MOTOR

Removal

The motor is an integral part of the rear hub. Removing the motor consists of disconnecting the QR connector, and then removing the rear wheel. The procedure is described below.

1. Shift the chain to the outermost rear cog on the freewheel.
2. Squeeze the top of rear brake arms together and free the rear brake cable from the bracket on the left arm (A, **Figure 5**).
3. Disconnect the QR connector (A, **Figure 12**) as described above in this chapter.
4. Remove the hardware that secures the motor torque arm to the left seat stay (**Figure 13**).
5. Remove the axle-nut-cover from each end of the axle.



6. Remove the axle nut and washer on each side of the hub. If necessary, hold one nut tight while you break the other loose.
7. Rotate the derailleur clockwise (rearward) around its mounting bolt and lower the wheel from the frame until the rear cogs clear the derailleur.
8. Remove the wheel from the left side of the E-Bike®.

Installation

1. Apply grease to the axle threads.
2. From the left side of the E-Bike®, position the wheel so the outmost cog is between the upper and lower chain runs.
3. Rotate the derailleur rearward so the outmost cog engages the upper chain run.
4. Lift the wheel rearward and up into the axle slots in the dropouts. Be sure the outmost cog remains engaged with the top chain run.
5. When the wheel is properly installed, the washer and nut sit outside of the dropout (**Figure 14**).



6. If removed, loosely reinstall the axle nuts and washers. Be sure the textured side of the washers faces inward toward the hub.
7. Finger tighten the axle nuts.
8. Secure the motor torque arm to the frame seat stay. Apply Loctite 242 (blue) to the threads of the mounting bolt, and tighten the nut securely (**Figure 13**).
9. Connect the QR housing connector as described above in this chapter.
10. Center the wheel between the chain and seat stays. Move the axle as necessary within the dropout so the wheel is centered. This is critical. Take the time to assure that the wheel is properly centered between the chain stays and between the seat stays. Tighten each axle nut to the torque specification in Table 4.
11. Reconnect the rear brake cable to the bracket on the left caliper arm (**A, Figure 5**).
12. Also operate the brake to assure that the rim is centered between the brake pads.

HEADLIGHT

Disassembly

NOTE

The lens in the E-Bike® is glass. Take care so it does not break during removal.

1. Unscrew the bezel (**A, Figure 15**) from the headlight housing.
2. Remove the bezel, rubber gasket, and the lens from the housing. Do not lose the rubber gasket (**B, Figure 15**). It may come out with the bezel or the lens.
3. Gently pull the reflector from the headlight housing.
4. Disconnect the black wire (**A, Figure 16**) from the spade terminal on the reflector housing.

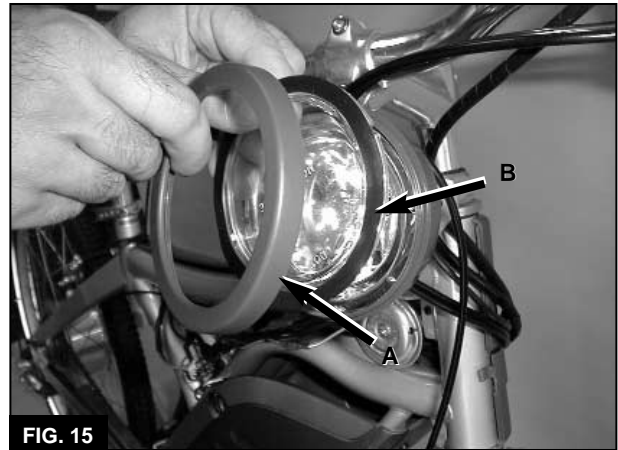

5. Disconnect the white wire (**B, Figure 16**) from the blue electrical lead from the headlight bulb, and remove the reflector from the E-Bike®

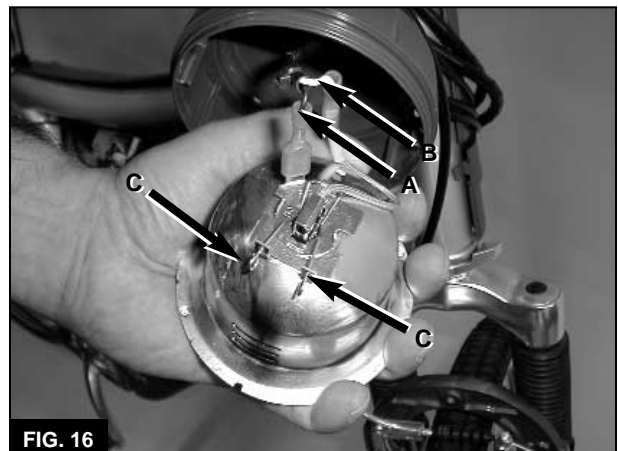

Assembly

1. Be sure the rubber gasket is properly seated inside the bezel.
2. Connect the white wire (**B, Figure 16**) to the blue wire from the headlight bulb.
3. Connect the black wire (**A, Figure 16**) to the spade terminal on the reflector housing.
4. While pulling the harness wire from the rear of the headlight housing, fit the reflector inside the headlight housing. Rotate the reflector so its three cutouts are at 3, 6, and 9 o'clock.
5. Press the reflector into the headlight housing so the cutouts at 3 and 9 o'clock engage the tabs (**Figure 17**) on the headlight housing.
6. Install the lens into the headlight housing so the DOT on the lens sits at 12 o'clock on the housing.
7. Carefully screw the bezel onto the housing until the rubber gasket seals the assembly.



FIG. 17

Headlight Bulb Replacement

1. Remove the reflector from the headlight housing as described above in this chapter.
2. Release the arms (C, **Figure 16**) of the bulb clip from the clasp on the reflector housing.
3. Rotate the clip up and lift the bulb from the reflector housing. See **Figure 18**.

NOTE

Do not touch the glass on the new bulb. Halogen bulbs get extremely hot, and the oils from your hand will create a hot spot that will lead to premature failure. If you inadvertently touch the bulb, clean the area with alcohol.



FIG. 18

4. Install the new bulb so its cutouts engage the tabs on the reflector and the wire from the bulb faces the clip hinge.
5. Rotate the clip so the blue wire is between the clip arms, and secure the arms (C, **Figure 16**) in the clasp. Be sure the clip rest in the groove on each side of the bulb socket as shown in **Figure 16**.

6. Install the reflector and assemble the headlight as described above.

Headlight Adjustment

Adjust the headlight according to Department of Motor Vehicle regulations in your state.

1. Set the E-Bike® on a level surface approximately 25 feet from a wall.
2. Have a friend sit on the bike and hold it vertically. Be sure the tires are inflated to the proper inflation pressure when adjusting the headlight.
3. Draw a horizontal line on the wall that is 35 inches above the floor/ground.
4. Turn the headlight on.
5. The main beam of light should be centered on the horizontal line. That is, there should be an equal amount of light above and below the line. If necessary, adjust the headlight by performing the following:
 - a. Loosen the headlight locknut (**Figure 19**) behind the headlight housing.
 - b. Tilt the headlight housing up or down until the beam is centered on the horizontal line.
 - c. Tighten the locknut. Torque the headlight locknut to the specification in Table 4.



FIG. 19

TAILLIGHT

Replacement

The LEDs in the taillight cannot be replaced. If the taillight LEDs burn out, install a new taillight assembly.

1. Be sure the key power knob is OFF, and remove the battery pack from the compartment.

2. Disconnect the taillight/brake light connector under the seat (**Figure 20**).



FIG. 20

3. Remove the two taillight mounting nuts (**Figure 21**), and remove the taillight assembly from the seat bracket.

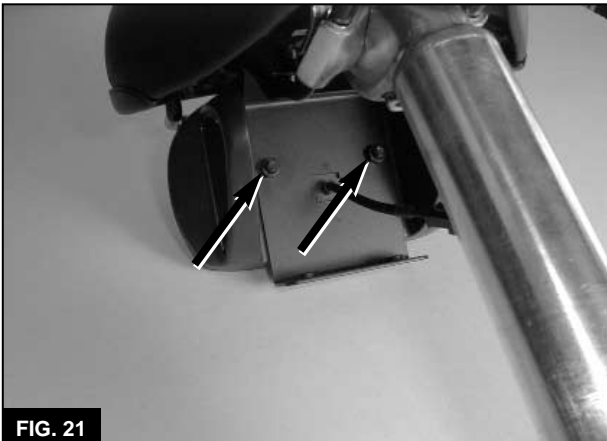

FIG. 21

4. Fit a new taillight assembly in place, and secure it with the two taillight mounting nuts. Torque the nuts to the specification in Table 4.
5. Connect the taillight/brake light connector (**Figure 20**).

TROUBLESHOOTING

General instructions

Find the symptom that describes the condition you are trying to correct, and perform each of the listed tests in the indicated order until the fault is identified. Once the source of a problem is found, take the necessary action to repair the faulty component.

When performing a particular test, follow the test procedures step-by-step until the problem is identified. Perform the procedures in the indicated order unless instructed to proceed to

another step. Before moving on to a next step, reconnect any part that had been disconnected unless instructed otherwise.

Troubleshooting Symptoms

A. The system does not beep GO and the LEDs do not flash at power ON.

1. Perform the battery voltage test.
2. Perform the battery contact test.
3. Perform the controller fuse test
4. Perform the power knob test.
5. If all of the above components work properly, replace the controller.

B. The controller fuse is blown.

NOTE

The controller fuse blows whenever there is a failure in either the headlight, horn, or taillight circuit. Do not simply replace a controller fuse without solving the problem. The new fuse will also be blown. Perform the following tests, correct the problem, and then replace the controller fuse.

1. Perform the headlight resistance test.
2. Perform the horn resistance test.
3. Perform the taillight test.

C. The system turns on, but the motor does not operate when the throttle is applied.

1. Turn the power knob ON, and turn on the headlight. The light should turn on. If the headlight does not work, perform the headlight resistance test. If the light turns on, continue with step 2.
2. Perform the QR connector test.
3. Perform the brake sensor operation test.
4. Perform the brake sensor continuity test.
5. Perform the throttle control test.
6. Perform the throttle test.
7. Perform the motor test.
8. If all of the above components work properly, replace the controller.

D. The bad beep sounds and the LEDs flash continuously when the power knob is turned ON.

1. Perform the throttle control test.
2. Perform the throttle resistance test.
3. If all of the above components work properly, replace the controller.

E. The system turns on, but the headlight does not operate.

1. Remove the battery, and turn the power knob to ON to discharge the capacitor in the controller.
2. Remove the lens from the headlight and visually inspect the bulb. Replace the bulb if it is blown.
3. Perform the headlight bulb resistance test.
4. Perform the headlight resistance test.
5. Perform the headlight switch test.
6. If all of the above components work properly, replace the controller.

F. The system turns on, but the horn does not operate.

1. Remove the battery, and turn the power knob to ON to discharge the capacitor in the controller.
2. Perform the horn switch test.
3. Perform the horn resistance test.
4. If all of the above components work properly, replace the controller.

G. The system turns on, but the taillight does not operate.

1. Remove the battery, and turn the power knob to ON to discharge the capacitor in the controller.
2. Perform the brake sensor operation test.
 - a. If only one brake sensor fails the test, perform the brake sensor continuity test on that sensor.
 - b. If both brake sensors fail the test, perform the taillight test.
3. If all of the above components work properly, replace the controller.

H. The charger LED turns red and the fan operates, but the charger does not turn off within four hours.

1. Unplug the charger immediately.
2. Perform the charger test described in Chapter Three.
 - a. If the charger is faulty, replace it.
 - b. If the charger works properly, replace the battery.

Test Procedures

Battery contact test

1. Remove the battery pack and visually inspect the terminals in the battery pack and on the terminal block. If they are dirty, clean them with contact cleaner.

2. Reinstall the battery pack into the E-Bike®. Push the bottom of the battery pack into the battery compartment with your hand, and turn the power knob ON. The problem is solved if the E-Bike® beeps GO and the LEDs flash.

3. Measure the voltage between the controller fuse and the brake sensor #2 terminal by performing the following:

- a. Disconnect a brake sensor connector (**D or E, Figure 1**) from its terminals on the controller.
- b. Connect a digital volt ohmmeter positive (+) probe to a terminal on the controller fuse. Connect the meter negative (-) probe to the brake sensor's #2 terminal on the controller board.
- c. Turn the power knob ON, and check the voltmeter.

4A. The contacts are good if the voltage is 31-39 volts.

4B. If the voltage is less than 31 volts, the battery to terminal block contact is poor. Shim the terminal block by performing the following:

- a. Loosen the two mounting screws (**A Figure 6**) and lift the terminal block (**B, Figure 6**) from the frame.
- b. With the mounting screws still installed through the terminal block, place a washer (1 mm thick) over the end of each mounting screw.
- c. Reinstall the terminal block so the washers are between the frame and the back of the terminal block.

Battery fuse test

1. Remove the cover from the charger and visually inspect the battery fuse. If the fuse is blown, replace the fuse and replace the controller. See the CAUTION below.

2. Check the continuity across the battery fuse terminals. There should be continuity. The fuse is blown if there is no continuity. Replace the battery fuse and replace the controller. See the CAUTION below.

CAUTION

A safety system is built into the controller. You must replace both the battery fuse and the controller whenever the battery fuse is blown. If you do not replace the controller, it will blow the new battery fuse and cause further damage in the system.

Battery voltage test

1. Remove the battery pack from the E-Bike®.
2. Use a digital volt ohmmeter to measure the voltage across the terminals at the bottom of the battery pack.
 - a. The battery is good if the voltage is 31-39 voltage.
 - b. If battery voltage is 0 volts, perform the battery fuse test.
 - c. If the battery voltage is less than 31 volts, perform the battery pack test described in Chapter Three.

Brake sensor continuity test

1. Disconnect the brake sensor connector (D or E, **Figure 1**) from the controller.
2. Check the continuity between the two pins in the sensor connector. The sensor should have continuity when the brake lever is applied. It should have no continuity when the brake lever is released.
3. If a brake sensor fails either check, adjust the sensor by performing the following:
 - a. Press the sensor with your thumb and reposition it on the brake lever housing.
 - b. Check the operation of the taillight while you operate the brake. The taillight should turn on when you apply the brake, and it should turn off when you release the brake.
 - c. If the taillight works properly, remove the sensor mounting screw. Apply Loctite 242 to the threads of the mounting screw and install the screw. Reposition the sensor until it works, and tighten the mounting screw securely.
4. If adjusting the sensor does not correct the problem, replace the brake lever assembly.

Brake sensor operation test

1. Operate the front brake, and watch the taillight.
2. The taillight should turn on when you apply the brake, and it should turn off when you release the brake.
3. Repeat step 1 for the rear brake.

Controller fuse test**NOTE**

The controller fuse blows whenever there is a failure in either the headlight, horn, or taillight

circuit. Do not simply replace a controller fuse without solving the problem. The new fuse will also be blown.

1. Remove the battery pack from the E-Bike® and turn the power knob to ON.
2. Visually inspect the fuse on the controller. Replace the fuse and perform troubleshooting procedure B if the fuse appears blown.
3. Check the continuity of the fuse with a digital volt ohmmeter. It should have continuity. Replace the fuse and perform troubleshooting procedure B if the fuse does not have continuity.

Headlight bulb resistance test

1. Be sure the bulb is cold.
2. Remove the bulb from the headlight.
3. Connect one probe of a digital volt ohmmeter to the spade connector at the end of the blue wire. Connect the meter's other probe to a metal part of the bulb housing.
3. Replace the bulb if the resistance is outside the specified range.

Headlight bulb resistance:

Approximately 0.5 ohms (cold).

Headlight resistance test

1. Disconnect the headlight connector (H, **Figure 1**) from the controller.
2. Connect the positive (+) probe of a digital volt ohmmeter to pin 1 on the connector and connect the ohmmeter's negative (-) probe to pin 3.
3. Note the reading on the ohmmeter.

Headlight resistance:

Approximately 0.5 ohms (cold).

4. Replace the headlight assembly if the reading is outside the specified range.

Headlight switch test

1. Disconnect the accessory control connector (B, **Figure 1**) from the controller.
2. Connect the probes of a digital volt ohmmeter to pins 1 and 2 on the connector.
3. Turn the headlight switch on and off and watch the meter. The circuit should have continuity when the switch is ON. It should have no continuity when the switch is OFF. Replace the accessory control if the headlight switch fails either test.

Horn resistance test.

1. Disconnect the horn connector (G, **Figure 1**) from the controller.
2. Connect the positive (+) probe of a digital volt ohmmeter to pin 1 on the connector and connect the meter's negative (-) probe to pin 2.
3. Note the reading on the ohmmeter.

Horn resistance:

Approximately 11 ohms.

4. Replace the horn if the reading is outside the specified range.

Horn switch test

1. Disconnect the accessory control connector (B, **Figure 1**) from the controller.
2. Connect the probes of a digital volt ohmmeter to pins 1 and 6 on the connector.
3. Press and release the horn switch, and watch the meter. The circuit should have continuity (close to zero ohms) when the switch is pressed. It should have no continuity (infinity ohms) when the switch is OFF.
4. If the switch fails either test, replace the accessory control.

Motor test

1. Remove the battery pack from the E-Bike®, and turn the power knob ON to discharge the capacitor on the controller.
2. Disconnect the QR connector.
3. Connect the negative (-) probe of a digital voltmeter to the red terminal on the motor side of the connector. Connect the meter's positive (+) probe to the blue terminal.
4. Spin the wheel backwards, and watch the meter. If any voltage is present when you spin the wheel backwards, the motor is good. If no voltage is present when you spin the wheel, replace the motor.

Power knob test

1. Remove the battery pack from the E-Bike® and turn the power knob to ON to discharge the capacitor in the connector.
2. Disconnect the throttle control connector (C, **Figure 1**) from the controller.
3. Use a digital volt ohmmeter to check the continuity across pins 3 and 4 in the connector. The throttle control should have continuity

when power knob is ON. It should not have continuity when power knob OFF. The throttle control is faulty if it does not pass both tests; replace it.

QR connector test

1. Inspect the cable on both sides of the connector. Be sure the cable does not rub against the wheel.
2. Disconnect the QR connector.
3. Plug the connector securely into its mate, and turn the power knob ON.
4. The problem is corrected if the motor operates.

Taillight test

1. Check the continuity in the taillight cable by performing the following:
 - a. Disconnect the taillight connector (F, **Figure 1**) from the controller.
 - b. Disconnect the taillight connector (**Figure 20**) under the seat.
 - c. Check the continuity on each wire (red, black and white) in the taillight cable.
 - d. Each wire should have continuity. Replace the taillight cable if any wire in the cable does not have continuity.
2. Reconnect the taillight connector (F, **Figure 1**) to the controller.
3. Connect a known-good taillight assembly to the taillight end of the taillight cable.
4. Check the operation of the taillight/brake light by turning on the headlight switch and by operating the brake levers. The original taillight assembly is faulty if this known good taillight assembly operates properly.

Throttle resistance test

1. Remove the throttle control connector (C, **Figure 1**) from the controller.
2. Connect the probes of digital volt ohmmeter to pin1 and pin 2 in the connector.
3. Check the resistance when the throttle is completely off and when the throttle is fully on.

Throttle resistance:

No throttle: Less than 1100 ohms
Full throttle: More than 3800 ohms

4. Replace the throttle control if either reading is outside the specified range.

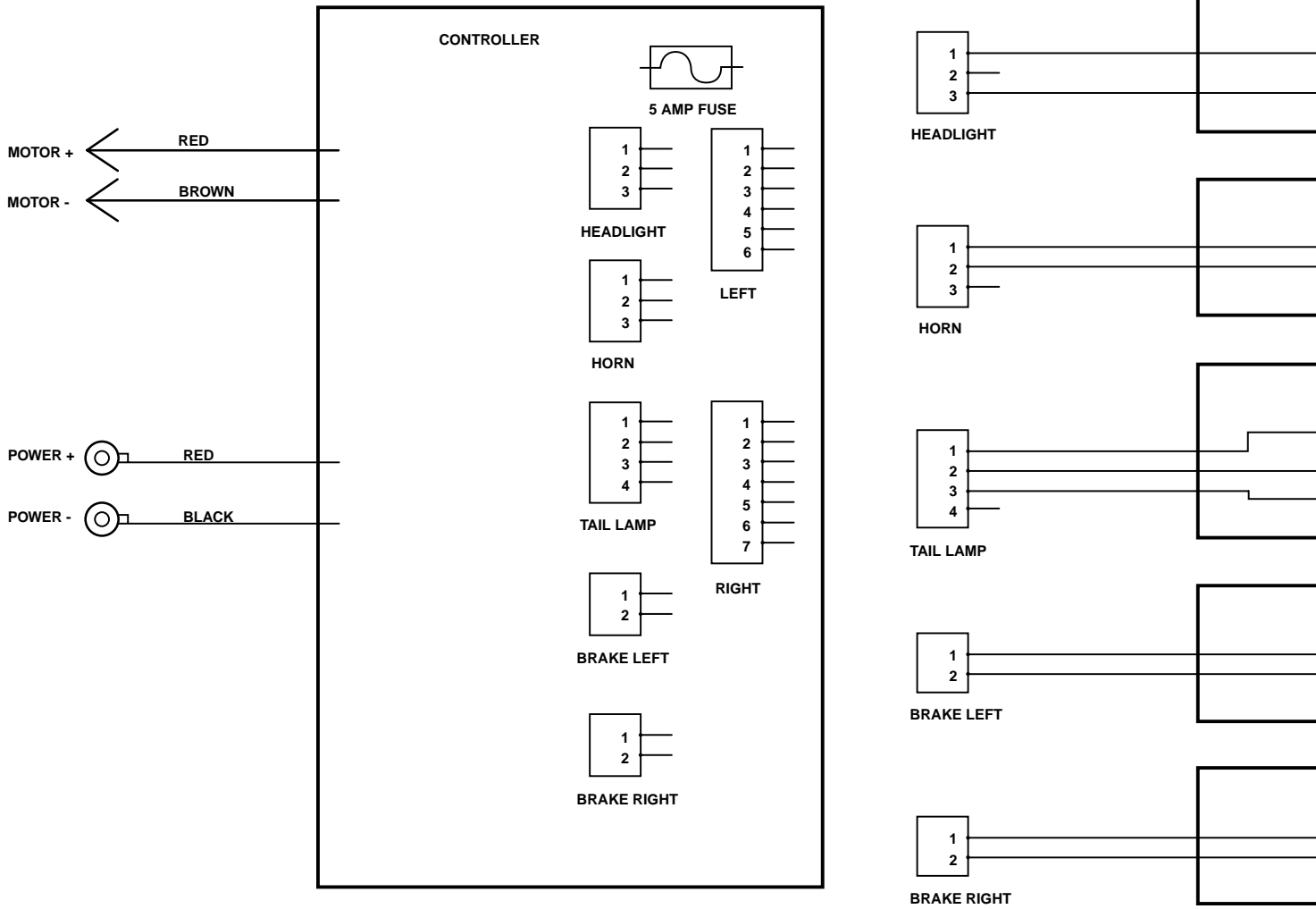

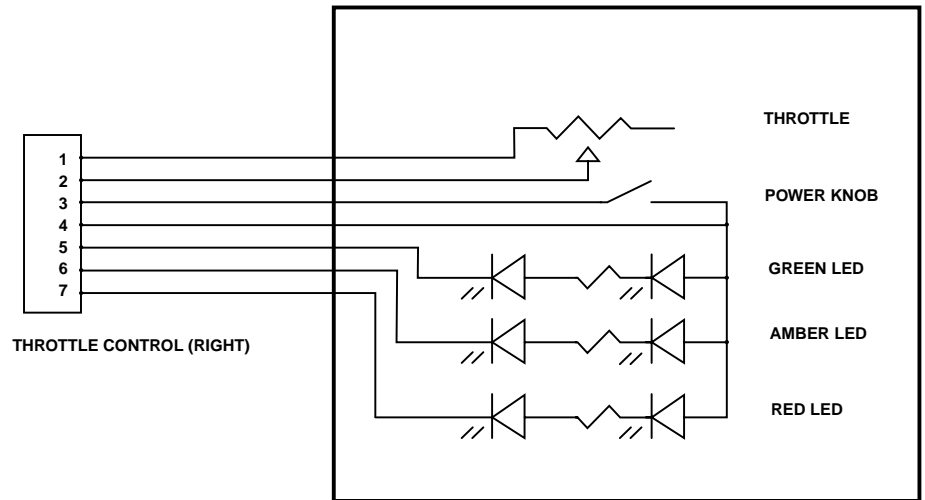
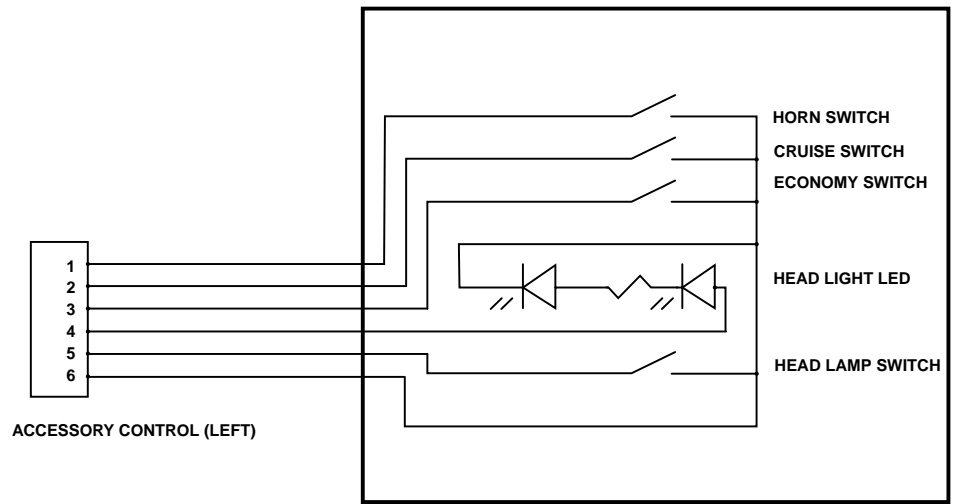
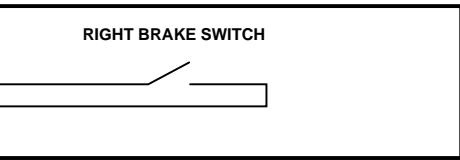
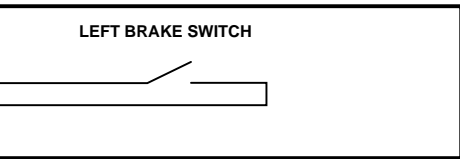
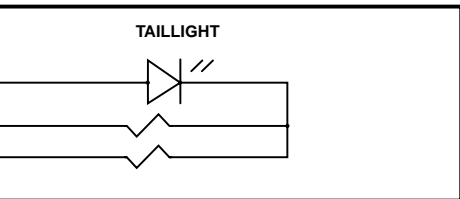
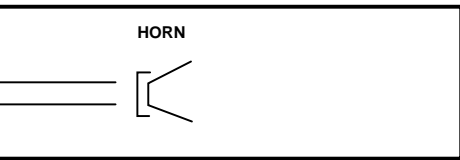
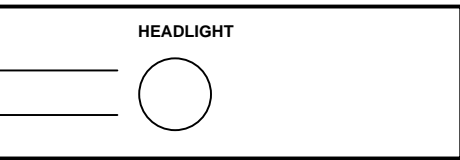

EV Global Motors Company

16201 Stagg Street

Van Nuys, CA 91406

www.ebike.com

818-756-0566 tel / 818-756-0563 fax

P/N: LIT-82001-01-36

