



POLARIS®
eBikes

Polaris and its vehicle body designs and names are registered trademarks of Polaris Industries Inc. used under license.

Polaris designs, engineers, manufactures and markets snowmobiles, all-terrain vehicles (ATVs), Victory motorcycles and the Polaris RANGER for recreational and utility use. Information about the complete line of Polaris products, apparel and vehicle accessories is available from authorized Polaris dealers or anytime from the Polaris homepage at www.polarisindustries.com.



POLARIS®
eBikes

POWERED BY



VANTAGE



www.polarisebikes.com



EV501, EV511, EV502, EV512, EV503,
EV504, EV505, EV506, EV50X, EV51X, DL818.



POLARIS[®]
eBikes



⚠ WARNING

Read, understand, and follow all of the instructions and safety precautions in this manual and on all product labels.

Failure to follow the safety precautions could result in serious injury or death.

TABLE OF CONTENTS	
QUICK START	2
COMPONENTS	4
INTRODUCTION	7
SAFETY	8
PEDELEC AND S-PEDELEC BICYCLES.....	12
PRO RIDE™ BATTERY	13
SMART BATTERY CHARGER	16
DISPLAY – INFORMATION CENTER DASHBOARD.....	18
REGENERATION.....	20
MOTOR BIOSYNC.....	21
REPLACING A FLAT TIRE.....	22
TORQUE SPECIFICATIONS	24
TECHNICAL SPECIFICATIONS	24
FRAME DIMENSIONS.....	26
WARRANTY	28
DEALER SERVICE SCHEDULE.....	29
HANDOVER DOCUMENTATION	31

QUICK START

CHARGING THE PRO RIDE™ BATTERY

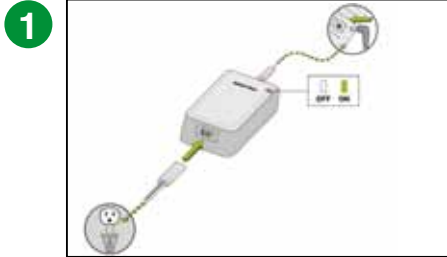

Green LED signifies the charger is connected to AC power

FULLY CHARGE UNIT FOR A FULL 6-8 HOURS BEFORE YOUR FIRST RIDE.

2 Charging in frame Charging out of frame

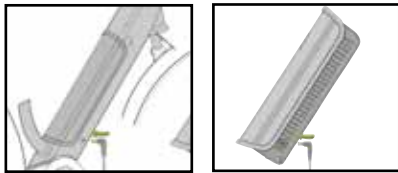

INSTALLING THE PRO RIDE™ BATTERY

Connect internal battery connector located inside battery compartment, to the battery itself and lock it using the 2 metal prongs on the connector.

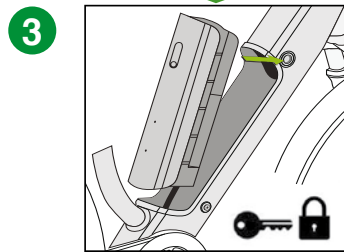
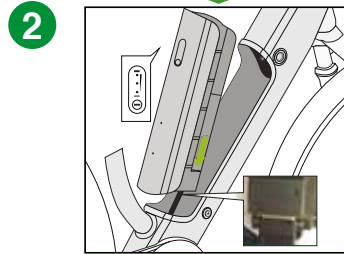
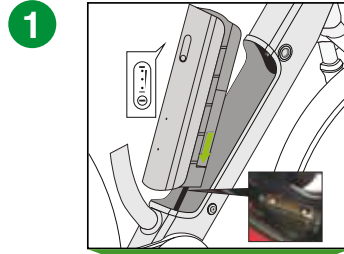

POWERING ON THE POLARIS eBIKE

1 Turn on the Pro Ride™ battery.

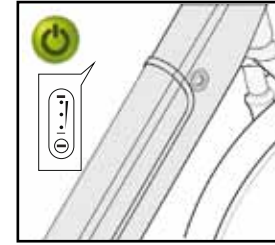

2 Turn on the IC Dashboard™.



3 Press the UP or DOWN button to scroll until the desired assistance or regeneration mode is reached (use the arrows for UP & DOWN)

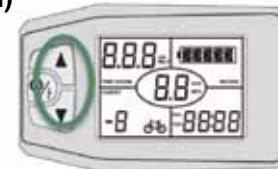

4 Start pedal rotation for pedal assistance.



TROUBLESHOOTING

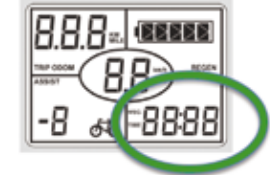

FAULT CODE	CAUSE	CORRECTIVE MEASURE
F01	Internal error in the motor	Have the hall sensor in the internal motor checked by authorized dealer
F02	Connection problem in the motor	Check connections by authorised dealer
F03	Cadence sensor	Check cadence sensor connection by authorised dealer or shift gears to reset.
F04	Internal motor error	Check the internal drive circuit in the motor by an authorised dealer.
F05	Connection problem with LCD display	Check connections by authorised dealer.
F06	Motor temperature too high (above 80 C)	Allow the motor to cool down by turning off the unit and continuing to pedal without assistance.
F07	Power supply connection	Check the connection between the battery and motor. Have authorised dealer check battery.
F08	Temperature of battery pack too high (45 C)	Allow the battery to cool down by turning off the unit and continuing to pedal without assistance.
F09	Temperature of battery pack too low (below 2 C)	Allow the battery pack to warm up slowly in a warm location.
F10	Temperature sensor	Automatic sensor to indicate high motor temperature. Most cases, eBike will remain operational.
F11	Battery pack connection	Check the connection between the battery pack and the battery compartment in downtube.
F12	One or more buttons on the LCD display are stuck	Check if any buttons are stuck or blocked from dirt or debris. Clean as necessary.
F13	Gear is not aligned in the sensor box.	Shift through gears while pedaling
F14	Converter inside battery overheat	Let cool down for 5 minutes
F15	Motor overheat	Let cool down for 5 minutes otherwise unit will shut off and switch to F06.
F16	Battery overheat warning.	Allow the battery to cool down by turning off the unit and continuing to pedal without assistance.
F17	Battery voltage level too low. Unit is shut off.	Charge the unit fully for 6-8 hrs

CAUTION: Charge the battery in a dry place and ensure there is sufficient ventilation. Neither the battery nor the charger should be covered during charging. The charging process gives off heat, which must escape or it could lead to overheating and a possible fire hazard.

IMPORTANT: FULLY CHARGE BATTERIES BEFORE FIRST USE. Li-Ion (Lithium-Ion) batteries must be fully charged immediately when they are received and after each use. Optimal Li-Ion battery performance is reached after 3-4 charging cycles.

IMPORTANT: Always make sure the display and main power switch on the battery are turned OFF before charging or removing the battery. Leave battery at 50% charge level or more for extended periods of inactivity.

WARNING: Please read and understand all sections of this User Manual before riding your pedelec bicycle.

WARNING: The battery is very heavy, so ensure that you do not drop it as this could cause personal injury and/or damage the battery.

WARNING: Remove the key from the keyhole before riding. Replacement keys are available in case of loss upon registering online.

COMPONENTS



eBIKE COMPONENTS

1. Duo Drive motor
2. Pro Ride™ battery
3. Information Center Dashboard™ display
4. BioSync cadence and gear sensor
5. In-frame charging port
6. Battery safety lock
7. DuoDrive Motor quick disconnect location
8. Dual hydraulic disc brake levers



BICYCLE COMPONENTS

9. Rear rack mount
10. Suspension forks
11. Front tire quick release
12. Chain stay and crank
13. Bottom bracket
14. Rear derailleur
15. Drop outs
16. Reflectors X 2
17. Head set



MOTOR COMPONENTS

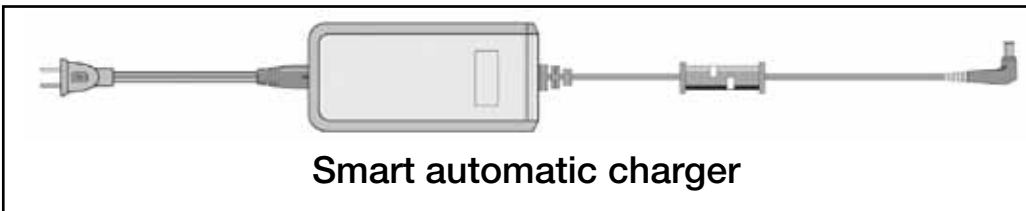
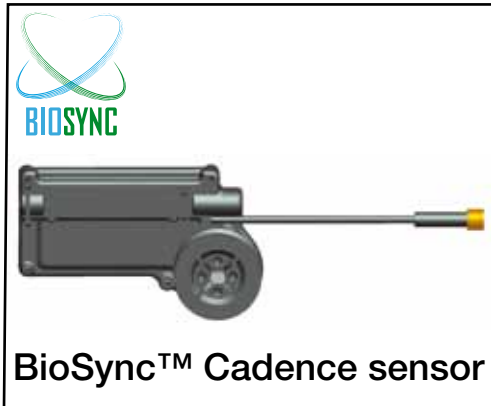
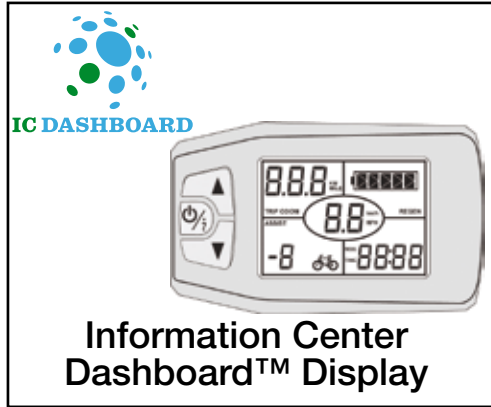

INTRODUCTION

Thank you for purchasing a Polaris® electric bicycle powered by EVantage, and welcome to our worldwide family of Polaris® owners. We proudly produce an exciting line of electric bicycles and motor systems.

i IMPORTANT: Please read this Owner's Manual before taking your first ride on your electric bicycle. It is important to familiarize yourself with the controls and features in order to best experience the ebike's full performance potential. We recommend that you keep the manual handy for future reference.

NOTE: This is not intended to be a comprehensive repair, service or cycling manual. Please contact your local Polaris®/EVantage™ dealer for your service and maintenance needs.

ABOUT THIS MANUAL

Throughout this Owner's Manual, you will find useful tips and important safety, performance, and maintenance information to ensure you safely enjoy all the features your electric bicycle has to offer.

SAFETY DEFINITIONS

The following symbols, warnings and cautions are used throughout this manual:

 **WARNING:** Indicates a potentially hazardous situation which could result in serious injury or death.

 **CAUTION:** Indicates a potentially hazardous situation which may result in minor or moderate injury, or is an alert against unsafe practices.

CAUTION (used without the safety alert symbol): Indicates a situation which could result in serious damage to your bicycle and possible voiding of your warranty.

IMPORTANT ELECTRIC BICYCLE SAFETY INSTRUCTIONS

 **WARNING: To avoid serious injury or property damage:** Polaris® electric bicycles are intended only for ON ROAD use. All off road, stunt, or companion riding is not recommended and may void the warranty.

 **IMPORTANT NOTE:** It is especially important that you know and obey the local laws specifically pertaining to electric bicycles, which vary by state and county.

IMPORTANT BATTERY AND CHARGER SAFETY INSTRUCTIONS

 **WARNING: To avoid serious injury or property damage:**

- Always turn OFF battery and turn OFF display before disconnecting battery
- Batteries should be stored in ambient temperatures above 10°C.
- Never allow batteries to freeze (below 0°C) as this will result in permanent damage.
- Never take apart or modify the battery charger.
- Never dispose of batteries in fire. This could cause an explosion and/or fire.
- Never connect the battery charger to appliances other than your Polaris® bicycle.

 **CAUTION: To avoid possible injury or damage to your bicycle:**

- Never attempt to open, disassemble or modify the battery charger. This could result in a fire or electric shock. There are no user-serviceable parts inside; and opening the battery charger will nullify your warranty.

- Always turn your system off before disconnecting the battery or plugging in the charger to recharge the battery. Never turn the system on while the battery is charging.
- Do not touch the charger with bare skin during charging. High temperatures may cause burns.
- Never cover the battery charger or place objects on top of it. This could result in a fire or electric shock.
- Do not place the battery charger on uneven surfaces. Place the charger firmly on a flat, stable, dry surface.
- Do not use the charger in high temperatures. Overheating or fire may result.
- Only use the battery charger in a dry location. Do not place the charger in water or other liquids. Do not place or store the charger where it can fall or be pulled into a tub or sink. Do not clean the charger with a water spray or the like.
- Never rotate the pedals while your bicycle is charging. The cord may wrap around the pedal or crank, causing damage to the cord, which could result in electric shock or fire.

CAUTION: To avoid damage to your bicycle or charger:

- Only use the original battery charger supplied with your Polaris® bicycle.
- Always charge batteries in a cool, well-ventilated area to avoid overheating. Never charge batteries in direct sunlight.
- Do not apply pressure to the power cable or the charger plug.
- Be sure to insert the charger plug securely into a functioning AC mains wall socket.
- Never touch the plug with wet hands.
- Keep the battery charger out of reach of children and pets.
- Do not use a plug or socket that is dirty, wet or dusty. Clean the plug with a lint-free, dry cloth.
- Always remove the plug from the socket gently by the plug. Never pull the cord.
- Do not use this battery charger with an extension cord.

HELMETS

! **CAUTION:** To avoid possible injury, we strongly advise that a properly fitting, ANSI or SNELL approved bicycle safety helmet be worn at all times when riding your electric bicycle. The correct helmet should:

- be comfortable,
- be lightweight,
- have good ventilation,
- fit correctly,
- cover forehead, and.
- be securely strapped on.



NIGHT RIDING

! **CAUTION:** To avoid possible injury, we recommend you ride at night only when necessary. When doing so, take the following precautions:

- Use a properly functioning lighting set comprised of a white front lamp and a red rear lamp.
- If using battery powered lights, make sure batteries are well charged.
- Wear reflective and light coloured clothing to increase visibility.
- Exercise extra caution and use familiar roads with adequate street lighting if possible.

WET WEATHER

! **CAUTION:** To avoid possible mild electric or irreversible damage to your electric bicycle, we recommend you do not ride in wet weather. This electric bicycle is not intended for use in water (such as damp roads, puddles, rain, streams, etc.). It is not intended for storing or parking in locations that are exposed to the natural elements. Never immerse the bike in liquids, as the electrical system may be damaged.

Before your first ride, please consult the instruction manuals of the individual component manufacturers, which were supplied with your bike or are available online.

Your authorized dealer will be happy to answer any further questions you have after reading this manual. Please ensure that your bike is ready for use and is adjusted to fit your body.

That means:

- Set the position and fixture of the seat and handlebar.
- Check the assembly and settings of the brakes.
- Secure the wheels into the frame and fork.

- Check the tire pressure.
- Check that the battery is properly secured.

To ensure that you enjoy a safe and comfortable riding position, please allow your authorized dealer to set up your handlebar and stem.

Adjust the seat to a safe and comfortable position for you.

Allow your authorized dealer to set up the brakes so that the brake levers are always within easy reach. Ensure that you know which lever operates which brake.

! **WARNING!** Before you switch the system on, ensure that the cover of the magnetic rubber cap is secure in place.

! **WARNING!** Modern braking systems might be more powerful or have a different functionality and behave differently than those that you are used to. Please take an initial test ride to familiarize yourself with the brakes in a safe, open space before setting off on your first ride with the bike.

Also remember that the effectiveness of brakes can be different than you are used to in wet conditions or on slippery surfaces. Please take into account the possibility of longer braking distances on slippery surfaces when riding.

! **WARNING!** Always apply the bicycle's brakes before you set foot on the pedal! Both brake levers are integrated with an automatic motor cut-off switch. The motor drives switch. The motor drives as soon as you push the pedal. This force is unfamiliar and can lead to falls, danger or accidents in traffic, which could result in injury.

GENERAL PREPARATION

- Practice operating and riding your bicycle in a quiet and safe place before you take to public roads.
- Ensure that the wheels are securely fastened in the frame and fork. Check that the wheels and thru axles as well as all important nuts and bolts are secure.
- Lift your bicycle up slightly and drop it onto the ground from about 4cm in the air. If it rattles or makes any unusual noise, please ask a authorized dealer to identify and fix the problem before you ride.
- Push the wheels forward with the brakes pulled. The back brake should completely prevent the back wheel from moving, while the front brake should lift the back wheel off the ground with its braking effect. The bicycle's steering should not rattle under braking or exhibit any play.
- Check the air pressure in the tires. You will find instructions about correct tire pressures on the sides of the tires.

ABOUT PEDELEC AND S-PEDELEC BICYCLES

A **pedelec** (“pedal electric”) bicycle provides a top assisted speed up to 20 mph. Pedelec class e-bikes are regarded as bicycles, and, as such, the only regulations the rider needs to familiarize himself with are the standard local ordinances for sharing the road safely on a bicycle.

S-Pedelec (“Schnell-Pedelec” or “Speedy-Pedelec”) bicycles provides a top assisted speed up to 28 mph. S-Pedelec ebikes are usually classified as mopeds. Depending on local jurisdiction, these ebikes may require registration and insurance. The rider may also need to obtain a license and be required to wear a helmet. Rules and regulations for operating an S-Pedelec bike may vary with jurisdiction.

THROTTLE ENABLED

Some models come equipped with a throttle for pedaless power. To engage the throttle, simply begin to pedal the bike, (this disengages the safety) and press the throttle lever. Models not including a throttle, can have throttle added via the quick connection on the handle bar. Throttles are all limited to a 20 mph speed, but will not affect the overall pedal assistance speed. Please ask your dealer for more information.

PRO RIDE™ BATTERY SYSTEM



Polaris® eBike’s Advanced Battery Management System is designed by EVantage™ engineers and used exclusively for Polaris® eBikes. The software analyses the motor drive system for optimum battery efficiency and for the ultimate in rider performance. The BMS also records and displays valuable data on the entire motor and battery system for ease of service and maintenance.

“Fuelling” the Polaris® eBike is the EVantage™ ProRide™ lithium-ion battery system. This removable power pack is mounted in the down tube, providing the center of gravity necessary for trail riding and urban street riding. Each battery takes 3 to 4 hours to charge using the Smart Charger system and also comes with a battery status level indicator on both the battery and the IC Dashboard Display. Thanks to the latest lithium-ion technologies and our engineered Battery Management Control System, these batteries are built for high durability and stamina during those uphill climbs.

Every Pro Ride™ battery is carefully manufactured and tested to ensure the highest degree of quality. Each Li-ion cell is individually circuit protected and controlled to maximize performance, reliability and ease of system diagnosis. The battery status (charge level) of the battery can be found on both the battery and the Information Center Dashboard.

The Li-ion battery should always be stored for extended periods of time at 50% or greater charge level.

CAUTION: To avoid damage to your bicycle’s battery:

- Please read the instructions and check the battery before using the bicycle for the first time.
- Do not let the battery freeze. Never recharge a frozen battery



CAUTION: The battery container should never be opened, as electric shock may result. Contact your authorised dealer should you suspect a battery malfunction.

TRANSPORT

The battery packs are subject to the Dangerous Goods Legislation requirements. Private users can transport battery packs by road without further requirements. When being transported by commercial users or third parties (e.g. via air transport or forwarding agency), special requirements on packaging and labelling must be observed (e.g. ADR Regulations). For preparation of the item being shipped, an expert for hazardous material can be consulted as required. Dispatch battery packs only when the housing is undamaged. Tape or mask off open contacts and pack up the battery pack in such a manner that it cannot move around in the packaging. Please also observe possibly more detailed national regulations. In case of questions concerning transport of the battery packs, please refer to an authorised bicycle dealer. Bicycle dealers can also provide suitable transport packaging.

DISPOSAL



Battery packs, accessories and packaging should be sorted for environmental-friendly recycling. Do not dispose of the battery packs into household waste!



Defective or used battery packs/batteries, must be collected separately and disposed of in an environmentally correct manner. Please return battery packs that are no longer usable to an authorised Polaris® eBike dealer.

INSTALLING AND REMOVING THE BATTERY

In-Frame Models

INSTALLING:

1. Connect internal battery connector located inside battery compartment, to the battery and lock the connector in place with the 2 metal prongs.
2. Gently place battery inside battery compartment until the battery is securely in the compartment.
3. Seal and lock the battery in place using the supplied key.
4. Turn ON battery
5. Turn ON display

REMOVING:

1. a) Turn OFF display
b) Turn OFF battery
2. Unlock the battery container with the supplied key.
3. Unlock the 2 metal prongs that secure the battery connectors.
4. Disconnect battery from adaptor located inside frame.

Installation:

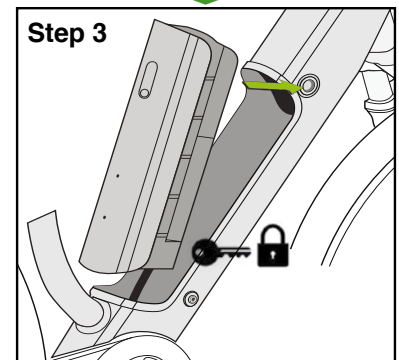
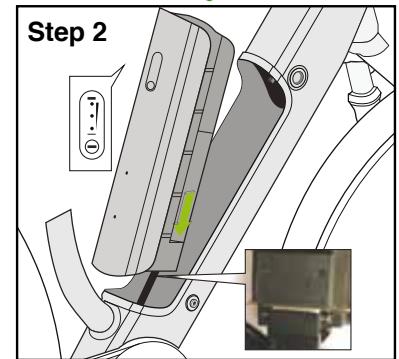
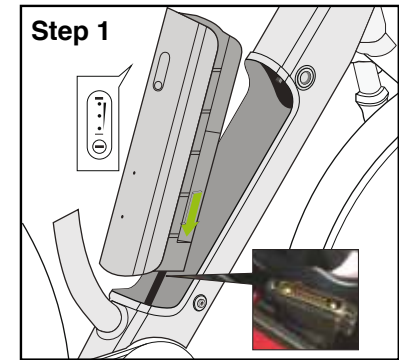

SMART BATTERY CHARGER

CHARGING THE BATTERY

WARNING! To avoid the risk of serious injury or property damage, observe all cautions and warnings outlined in the Safety section at the front of this manual when charging the battery.

IMPORTANT: Your electric bicycle battery is delivered in a partially charged state. **FULLY CHARGE UNIT FOR A FULL 6-8 HOURS BEFORE YOUR FIRST RIDE.**

Notes: We strongly recommend charging your battery after each ride in temperatures above 0°C. Avoid locations with limited ventilation.

Since the battery does not have a memory, it is not necessary to completely discharge the battery before charging it again.

The battery charger has a built-in shut-off feature when fully charged.

IMPORTANT: Always make sure the display and the main battery power switch are turned OFF before charging or removing the battery.

CAUTION: The battery container should never be opened. Doing so will void the warranty.

1. Make sure the display and the main battery power switch are in the off position.
2. Battery can be charged in or out of the frame.
3. Connect the battery charger to the AC power outlet.

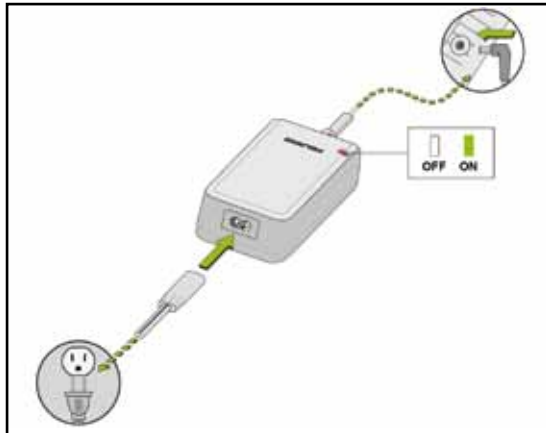

4. Connect the battery charger to the charging outlet located on the frame or directly to the battery.

5. Charging LED Indicators

Battery Charger	Green solid LED = Connected to AC power	
Battery	Red 0-30%, Yellow 30-60%, Green 60-100%, lights will appear solid once charge is complete.	
I.C. Display	5 bars = Full charge	

6. When charging is complete, unplug the charger from the wall, as well as from the bicycle.

APPROXIMATE BATTERY LIFE

If used in accordance with the guidelines in this manual, the Li-Ion battery has an expected life span of approximately 500 cycles for optimal use.

IMPORTANT: FULLY CHARGE BATTERIES BEFORE FIRST USE. Li-Ion (Lithium-Ion) batteries must be fully charged immediately when they are received and after each use. Optimal Li-Ion battery performance is reached after 3-4 charging cycles.

DISPLAY – INFORMATION CENTER DASHBOARD

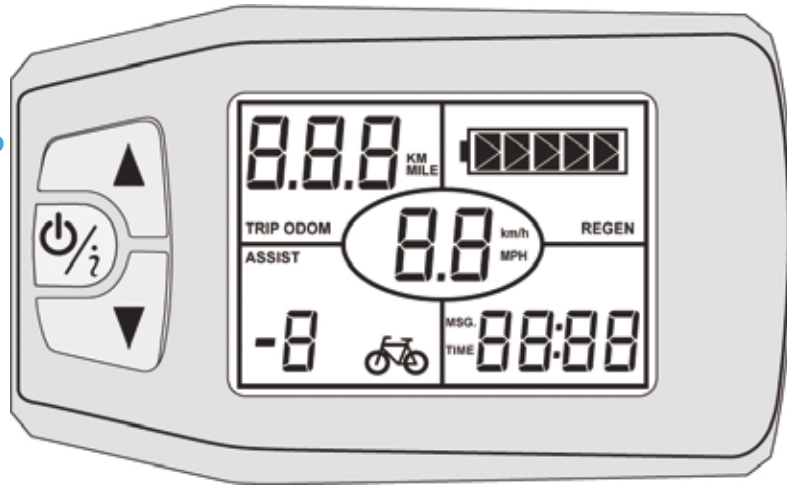

The IC Dashboard™ provides key riding information necessary for every rider. It displays speed, odometer, trip time, battery status and regeneration status. The display flashes REGEN whenever the motor is in regenerative function. Most importantly, EVantage has built-in software to automatically self diagnose itself. It informs the rider that troubleshooting may be required by displaying fault codes on the IC dashboard should there ever be a motor, battery or display issue. The display itself was built to be small in size, light in weight, and rain proof. The LED backlight allows for night time use of the display.

ECO, UTILITY, AND SPEED ASSISTANCE LEVELS

When the system is OFF, you are riding a conventional bicycle. To activate assistance, turn the system ON. The system activates at SPEED 3 level mode and displays current gear selection.

Note: The console automatically switches OFF after 30 minute of inactivity.

WARNING SIGNALS

WARNING Icon:

In the event of a technical issue, the WARNING icon will display along with the fault code in question

Empty Battery Warning

In the event the battery charge level becomes discharged, the empty battery icon will flash before the motor turns OFF automatically.

IC DASHBOARD™ CONTROL INSTRUCTIONS

	Press power button ON the battery, then turn ON IC Dashboard display.
	Press the UP or DOWN buttons to scroll up or down until the desired level is reached
	Speed 3 assist mode
	Utility 2 assist mode
	Eco 1 assist mode
REGEN	
-1	-1 Perpetual Arc Regeneration / Active Trail
-2	- 2 Perpetual Arc Regeneration / Active Trail
km/h <math>\leftrightarrow</math> MPH	To change the display from kilometres per hour to miles per hour, press, hold and release the UP button for 3 seconds and release.
	To scroll from odometer to trip distance and vice-versa, press (i) for 3 seconds Odom = Odometer Trip = Timed distance (automatically resets to zero when the eBike is turned OFF)
	To turn the LCD Backlight on/off, press and hold the “▼” button for 3 seconds

***Note:** When power on main battery is turned on, the current gear selection will be displayed on the IC dashboard

IMPORTANT: If there is motor vibration felt during operation, this is due to the bike being in an inappropriate gear for the riding terrain, or weak pedal cadence. To correct adjust gear accordingly and increase pedal cadence.

REGENERATION MODE

ACTIVE ARC REGENERATION	Regeneration automatically activates when using the brakes or when pedaling above certain speeds in all modes. Pedelec: above 21 MPH (speed-pedelec): above 29 MPH
PERPETUAL ARC REGENERATION (PAR)	When using the negative modes -1, -2, the motor acts as a generator and recharges itself while the rider is pedaling on flat or downhill. The motor will automatically provide pedal assistance should the terrain require it. Using either PAR modes, the motor will be generating some resistance to create the wattage to recharge the Pro Ride™ Battery -1 Perpetual ARC Regeneration (PAR): The motor regenerates up to 50W. -2 Perpetual ARC Regeneration (PAR): The motor regenerates up to 100W.

Note: REGEN will appear on the display when the battery is charging



ARCREGEN PERPETUAL REGENERATION

Our preferred riding mode is Regeneration mode (-1, -2) because a rider can regenerate power to the battery when pedaling, braking or speeding over 21/29 MPH when going downhill. When going uphill, the DuoDrive motor will assist the rider creating the perfect balance between decline regeneration and incline acceleration. An additional feature is the Back-Pedal Regen, which allows the rider to regen and slow down in curves by doing a short backpedal movement and creating Regen on-demand.



ACTIVE TRAIL TECHNOLOGY

Automatically delivers power when needed for acceleration up hills, and adjusts back to regeneration on flat or downhill.



BACK PEDAL REGEN

This electronic back pedal braking feature is utilized for slowing down the bike and capturing the power in the system to recharge the battery.

MOTOR – BIOSYNC MOTOR TECHNOLOGY

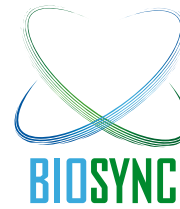

BioSync pedal assistance reads the power output of a rider resulting in a variable wattage motor system designed to provide the torque when climbing hills or conserve power for longer distance ranges. Feel the responsive pedelec power at your feet with BioSync's pedal assistance.

There are 5 different assistance settings to choose:

ASSISTANCE LEVEL	PEDELEC SPEED	RANGE**
3: (Speed mode)	Up to 20/25 mph*	20 miles
2: (Utility mode)	Up to 15 mph	35 miles
1: (Eco mode)	Up to 12 mph	50 miles
-1: (Perpetual ARC Regeneration) Active Trail	N/A	N/A
-2: (Perpetual ARC Regeneration) Active Trail	N/A	N/A

Note: Does not include Fat tire eBikes range which is up to 30miles in Mode 1

*Depends on model.

** Depends on weight, terrain and weather conditions.



GEAR SPEED TECHNOLOGY

The future of shifting gears on an eBike has arrived. At Polaris, we like speed and we believe shifting gears should be an integral part of the speed acceleration and deceleration process. Each gear on a Polaris eBike is programmed to provide the appropriate torque or acceleration based on the riding terrain and riding style. As you start pedaling, the burst of speed pickup is felt with each gear change to get you moving fast. BioSync pedal assistance is our proprietary cadence sensor which reads the cadence speed and power output. The instant pedal responsiveness is designed to provide the torque when climbing hills or conserve power for longer distances

INFLUENCES ON THE OPERATING RANGE

The operating range depends on many factors, such as:

- Assistance level
- Gear-switching ability
- Bicycle tires and tire pressure,
- Age and condition of the battery pack
- Route profile (inclines) and road or path conditions and surfaces
- Head wind and ambient temperature
- Weight of the eBike, rider and equipment/luggage

MOTOR AND REAR TIRE REPLACEMENT

REPLACING THE REAR TIRE



Step 1

Unfasten the two quick-disconnect cables connecting to the motor located on the rear chain stays.



Step 2

Remove safety plate on both sides and rear derailleur.



Step 3

Loosen axle nuts on both sides. Carefully remove entire wheel from rear drop outs.



Step 4

Perform needed repairs and reverse process. Be sure to install hardware with the correct torque settings as provided.



TORQUE SPECIFICATIONS

PRODUCT DESCRIPTION	TORQUE SPECIFICATION	PRODUCT DESCRIPTION	TORQUE SPECIFICATION
Stem steerer tube	45 in-lbf (5 Nm)	Rear derailleur	70-88 in-lbf (8-10 Nm)
Stem handlebar	45 in-lbf (5 Nm)	Front wheel axle	105 in-lbf (12 Nm)
Seat collar	55 in-lbf (6.2 Nm)	Rear wheel axle	133 in-lbf (15 Nm)
Seat post saddle rails	120 in-lbf (13.5 Nm)	Shifter	25-30 in-lbf (2.8-3.4 Nm)
Bottom bracket	355-445 in-lbf (40-50 Nm)	Head light	26-45 in-lbf (3-5 Nm)
Crank bolts	336-363 in-lbf (38-41 Nm)	Tail light	9-18 in-lbf (1-2 Nm)
Chain ring bolts	104 in-lbf (12 Nm)	Water bottle bolts	35 in-lbf (4 Nm)
Disc brake calliper bolts	53 in-lbf (6 Nm)	Kick stand bolt	89 in-lbf (10 Nm)
Disc brake rotor bolts	35 in-lbf (4 Nm)	Fender bolts	35 in-lbf (4 Nm)
Brake levers	35 in-lbf (4 Nm)	Fender stay bolts	35 in-lbf (4 Nm)

TECHNICAL SPECIFICATIONS

DuoDrive™ Motor

Model # EV030

- Rear hub, rated 750W
- EVantage Smart Controller
- Pedal Assistance motor support up to 20 MPH or 28 MPH depending on model
- Torque: 40nm nominal / 50nm peak
- Motor weight: 13 lbs.

BioSync™ cadence sensor and gear

Model # EV050

- Current output
- Pedal speed
- Detects gear setting
- BioSync™ sensor weight: <.1 lbs
- BioSync™ cadence gear sensor is replaceable.

Pro Ride™ Battery Pack

Model # EV010

- 44V 6Ah Lithium Pro Ride™ Battery
- 1 Battery version: Inframe
- Size of Inframe battery: <15 x 4.5 x 3.3 inches. The standard battery version is available in black, white and cream
- On/off button; State of charge is shown directly on the battery pack via 3 color LED
- Up to 500 recharge cycle life, before battery diminishes to 80% capacity
- Battery weight: 9.5 lbs.
- Battery comes with key to lock onto bike

Smart Charger

Model # EV020

- ETL/CE listed Smart battery charger
- Input: 100-240VAC, 50/60Hz, 1A
- Output: 12VDC, 4A
- Indoor use only
- Charging time: max. 3-4h
- Size: 6 x 3 in
- Weight: <2 lbs.

Information Center Dashboard™

Model # EV040

- Battery status level
- Size: 3.8 x 1.9 x 1.4 inches
- Weight: <1 lbs.
- The Information Center Display is replaceable
- Option: MPH or km/h
- Diagnostics
- Odometer
- Trip time and trip distance
- Speedometer
- Backlit LCD

FRAME DIMENSIONS

STEP OVER 500 MM (EV501, EV502)

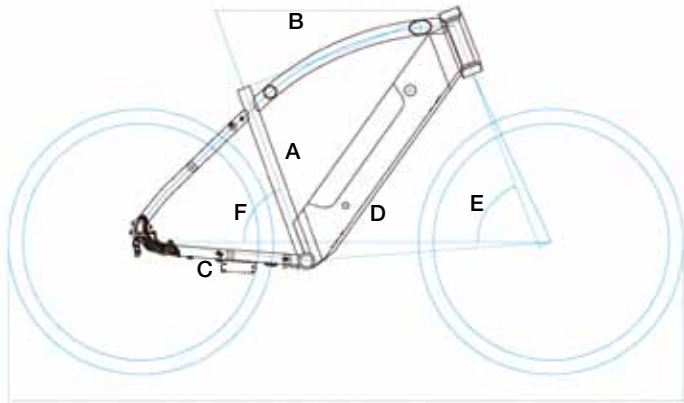

A	B	C	D	E	F
485	615	440	1085	69°	70°

HYBRID 470 MM (EV503, EV504, EV505, EV506)

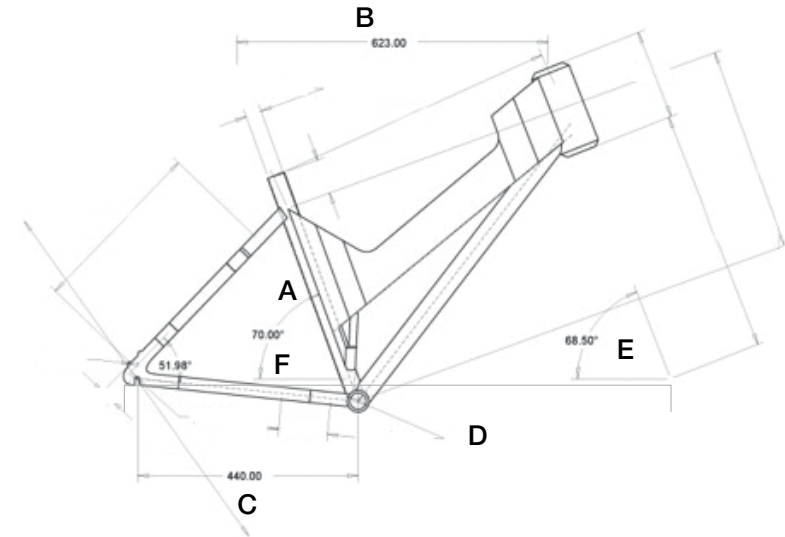

A	B	C	D	E	F
485	615	440	1117	69°	70°

STEP THROUGH 445 MM (EV511, EV512)

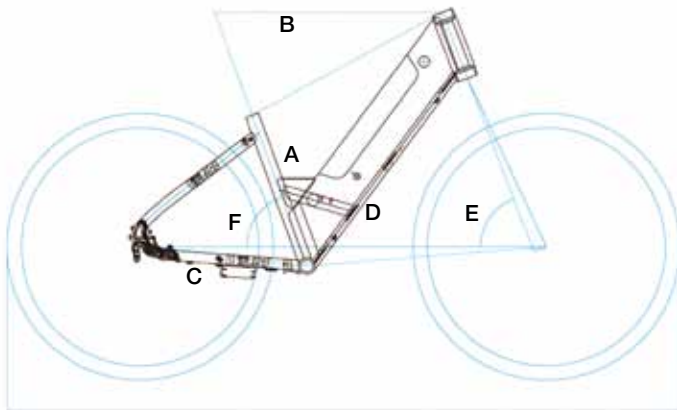

A	B	C	D	E	F
420	597	440	1065	69°	70°

WARRANTY

Liability for material defects does not cover normal wear occurring from the product's intended purpose. Components in the motor and deceleration system as well as tires, brake pads, chain, cassette, spokes and all contact points of the rider with the pedelec are all subject to use-related wear, as is the battery.

The battery is subject to aging and is therefore also a wearable part. Please note that the battery gradually loses its capacity depending on its age and operating life. Take this into account when planning journeys and ensure that you switch to a new battery in good time. Replacement batteries can be purchased from your Polaris eBikes authorized dealer.

See warranty card information included with your bicycle.

INSPECTION PLAN

You should service your bicycle on a regular basis. You can get more information about your bicycle's parts, as well as cleaning and maintenance directions, in the instruction manual provided by the respective component manufacturers or on their websites.

To ensure that your bicycle remains in a safe condition and meets the conditions of the warranty, the following terms apply:

- Clean your bicycle after every ride and check it for possible damage.
- Have an authorized dealer carry out inspections according to the schedule provided in this manual.
- Check that all screws and nuts are secure.
- Use a torque wrench to tighten screw joints.
- Clean and grease moving parts (excluding brake surfaces) according to instructions from the manufacturer.

The first inspection is particularly important for ensuring that your bicycle remains safe and problem-free. Cables and spokes stretch, while bolted connections can loosen.

DEALER SERVICE SCHEDULE

1st Inspection:

After approx. 125 miles

Work done:

Materials used:

Date: _____

Signature: _____

Dealer Stamp:

2nd Inspection:

After approx. 600 miles

Work done:

Materials used:

Date: _____

Signature: _____

Dealer Stamp:

3rd Inspection:
After approx. 1200 miles

Work done:

Materials used:

Date: _____

Signature: _____

Dealer Stamp:

4th Inspection:
After approx. 1800 miles

Work done:

Materials used:

Date: _____

Signature: _____

Dealer Stamp:

HANDOVER DOCUMENTATION

The pedelec listed in the pedelec identification on the below was assembled properly and was delivered to the customer ready-to-use.

Bicycle brand: Polaris eBikes

Model: _____

Colour: _____

Serial Number: _____

Battery date code: _____

Motor Number _____

Special Features: _____

Speed pedelec Pedelec

Functional checks for the following components:

- Wheels: Spoke tension, sturdiness, concentricity, correct tire pressure
- All screw joints: secure, correct mounting torque
- Gear system
- Brake system
- Functioning battery and charger

The following components were assembled and checked separately:

- The assembling/inspecting party completed a test ride
- The customer was instructed on how to use the pedelec
- Function check of the right front brake
- Function check of the left front brake

The following instruction manuals were supplied and explained:

- EVantage instruction manual
- Warranty card

- Bike has been registered by owner online or by mail sent to:

EVantage USA Inc.
27 Congress St. Suite 505
Salem, MA 01970



Purchase Date: _____

Owner: _____

Address: _____

Supplied by (dealer stamp):

Signature of the assembling party:

Date: _____

Dealer Stamp:

Signature of the customer:

Date: _____



POWERED BY



VANTAGE™

For more information,
visit www.polarisebikes.com



Polaris and its vehicle body designs and names are registered trademarks of Polaris Industries Inc. used under license.

Polaris designs, engineers, manufactures and markets snowmobiles, all-terrain vehicles (ATVs), Victory motorcycles and the Polaris RANGER for recreational and utility use. Information about the complete line of Polaris products, apparel and vehicle accessories is available from authorized Polaris dealers or anytime from the Polaris

homepage at
www.polarisindustries.com