



OWNER'S MANUAL
TURBO / TURBO X



TABLE OF CONTENTS

SPECIALIZED TURBO INSTRUCTIONS	2
1. QUICK START	3
Charging the battery	3
Starting the system	3
Removing / installing the battery	4
Checking the battery diagnostic	4
2. SPECIALIZED TURBO COMPONENTS	5
3. EG - DECLARATION OF CONFORMITY	6
4. INTRODUCTION	7
5. SAFETY INFORMATION	7
6. BEFORE THE FIRST RIDE	8
7. BEFORE EACH RIDE	8
8. LEGAL REGULATIONS	9
A. Intended use	9
9. BATTERY	10
A. Battery information system	10
B. Charge level display	10
C. Range	11
D. Removal / Installation	11
E. Cleaning	11
F. Storage	12
G. Transport	12
H. Disposal	12
10. CHARGER	12
A. Charging process	13
B. Cleaning	13
C. Disposal	14
11. USER INTERFACE	14
A. Turbo cyclocomputer functions	14
B. Joystick functions	14
C. Screen setup	15
D. Screen modes	16
D. Motor/support	17
E. Starting the system	17
F. Error codes displayed	18
12. TURBO DIAGNOSIS DECISION TREE	19
13. LIGHTS	20
14. NOTES ON ELECTRICAL AND ELECTRONIC COMPONENTS	20
15. MAINTENANCE AND CARE	20
16. DEALING WITH A FLAT TIRE / REMOVING A WHEEL	21
17. SERVICE PLAN	21
18. LUBRICATION	22
19. WARNING NOTICES	22
20. TORQUE SPECS	23
21. TECHNICAL INFORMATION	23
22. LEGAL REGULATIONS FOR S-PEDELEC ONLY (2002/24/EC)	24
A. Use on public roads	24
B. Other legal regulations	24
23. THE DIFFERENCE BETWEEN THE L1e S-PEDELEC AND PEDELEC	25
A. Regulations for L1e S-Pedelects	25
B. L1e S-Pedelects and cycle paths	25
C. Intended use	25
24. REPLACING PARTS ON YOUR L1e S-PEDELEC	26
Replacement tires	26
25. DEALER SERVICE SCHEDULE	27
HANDOVER DOCUMENTATION	28

SPECIALIZED BICYCLE COMPONENTS

15130 Concord Circle, Morgan Hill, CA 95037 (408) 779-6229
0000044203_OM_EN_R2, 07/14

Please note all instructions and notices are subject to change and updates without notice.
Please visit www.specialized.com for periodic tech updates.
Feedback: techdocs@specialized.com

SPECIALIZED TURBO INSTRUCTIONS

According to EN 15194 / 2002/24/EC

NOTE: The Specialized Turbo (L1e S-Pedelec or Pedelec or electric bicycle) is referred to in the Owner's Manual as a bicycle unless otherwise noted. For specific speed setting information, please refer to the "Motor/Support" section (page 17).

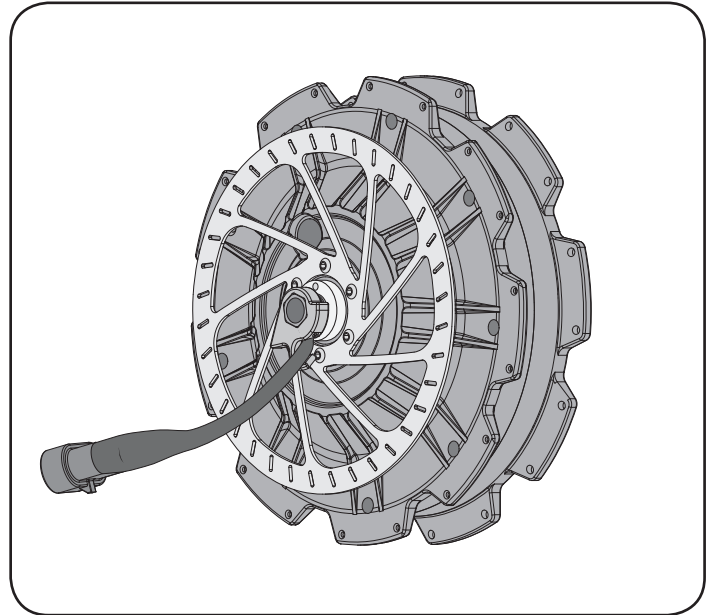
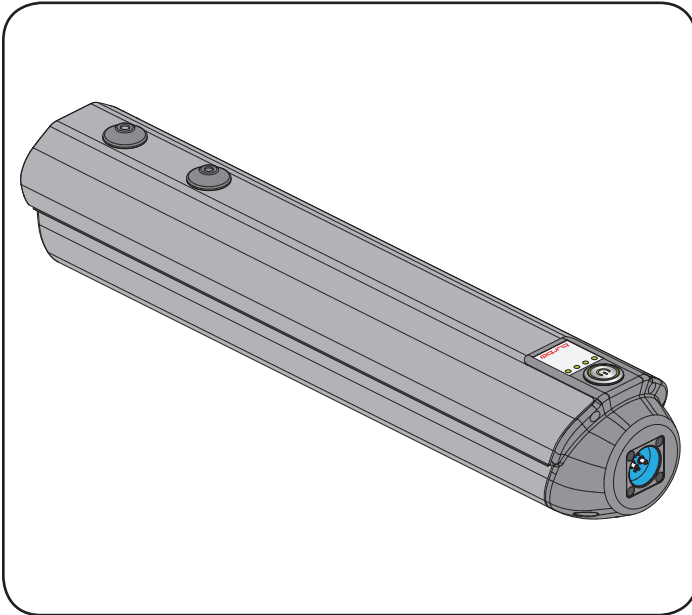
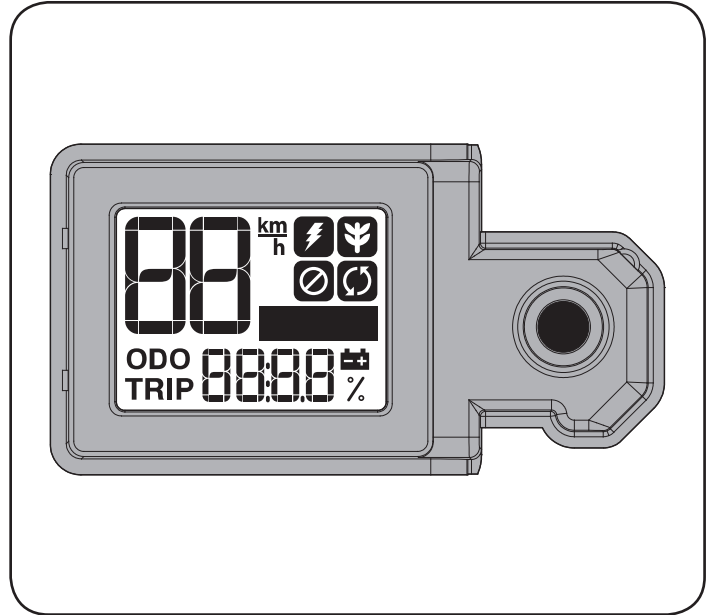
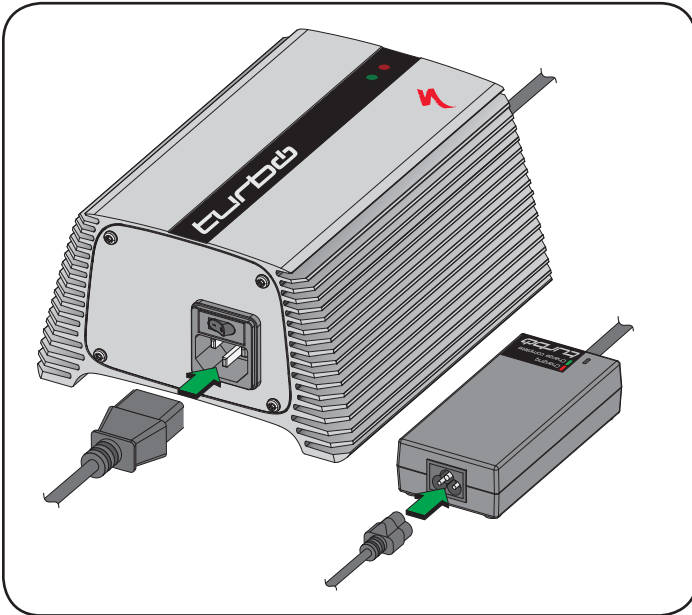

This instruction manual only contains information specific to your Specialized Turbo electric bicycle. General information, such as information on the technology used in this bicycle, is located in the general section of this instruction manual. Please read the instruction on how to use the bicycle technology as well as the instructions relating to the electric assist technology before you use this bicycle.

1. QUICK START

Charging the battery

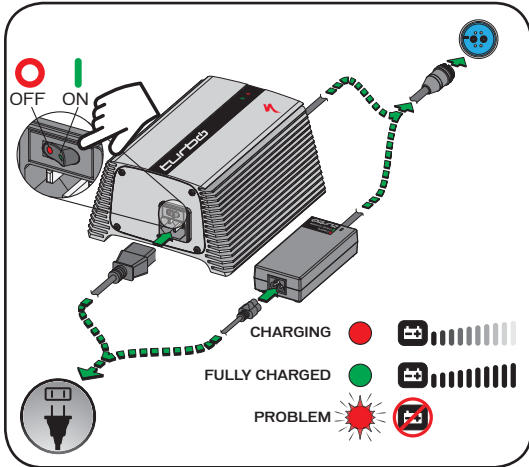

Starting the system

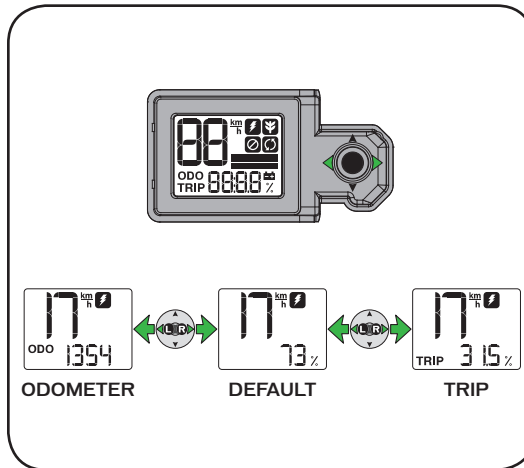
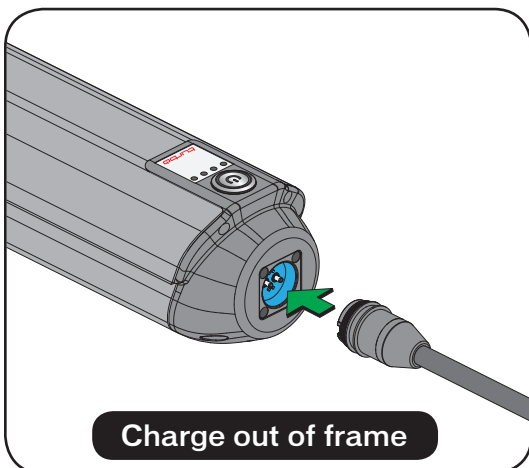
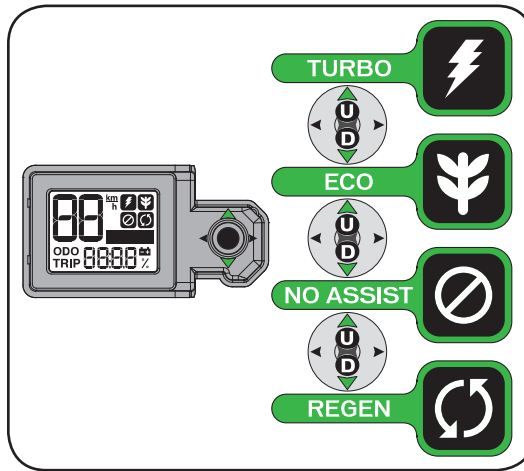
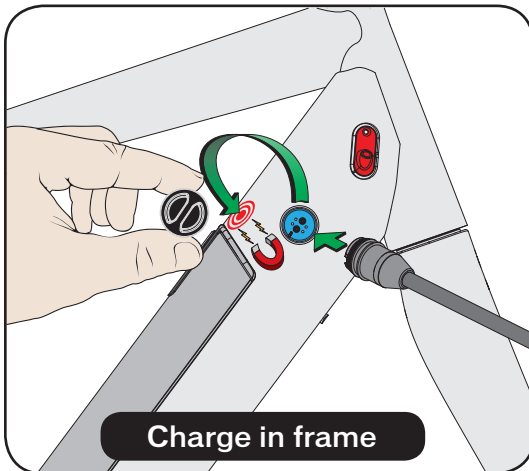
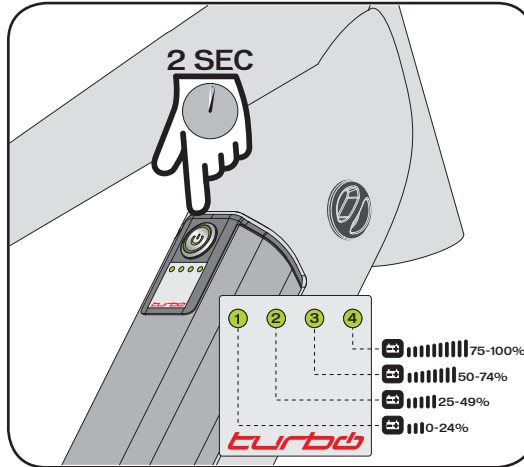

! If the diode on the charger flashes red, an error has occurred during charging. If this is the case, please remove the charger from the power socket immediately and contact your Authorized Specialized Dealer right away. Please only ride your bicycle again when this error has been corrected.

! Charge the battery in a dry place and ensure there is sufficient ventilation. Neither the battery nor the charger should be covered during the charging process. A lot of heat can be created during the charging process and such heat has to be able to escape. Otherwise this could lead to a danger of overheating and a possible fire hazard. Specialized recommends charging under supervision of the user.



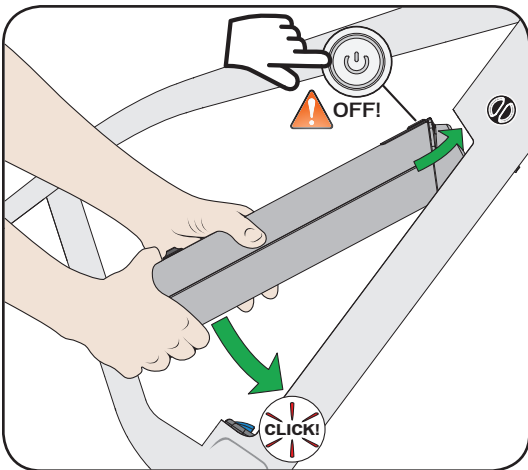
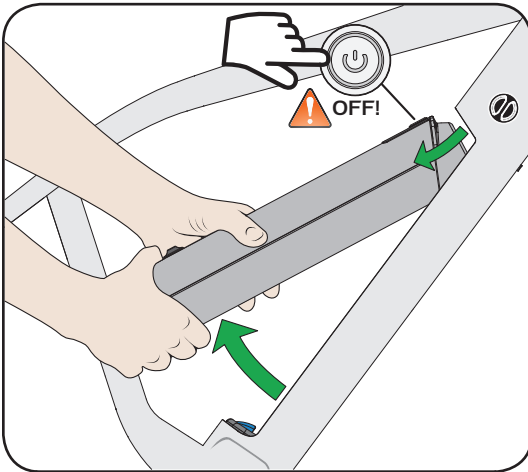
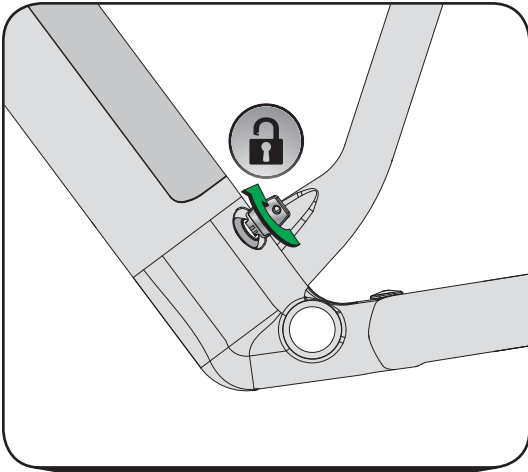

! If any issues arise with the startup, restart the system. For additional information, please refer to the “Starting the System” section (page 17).

Removing / installing the battery

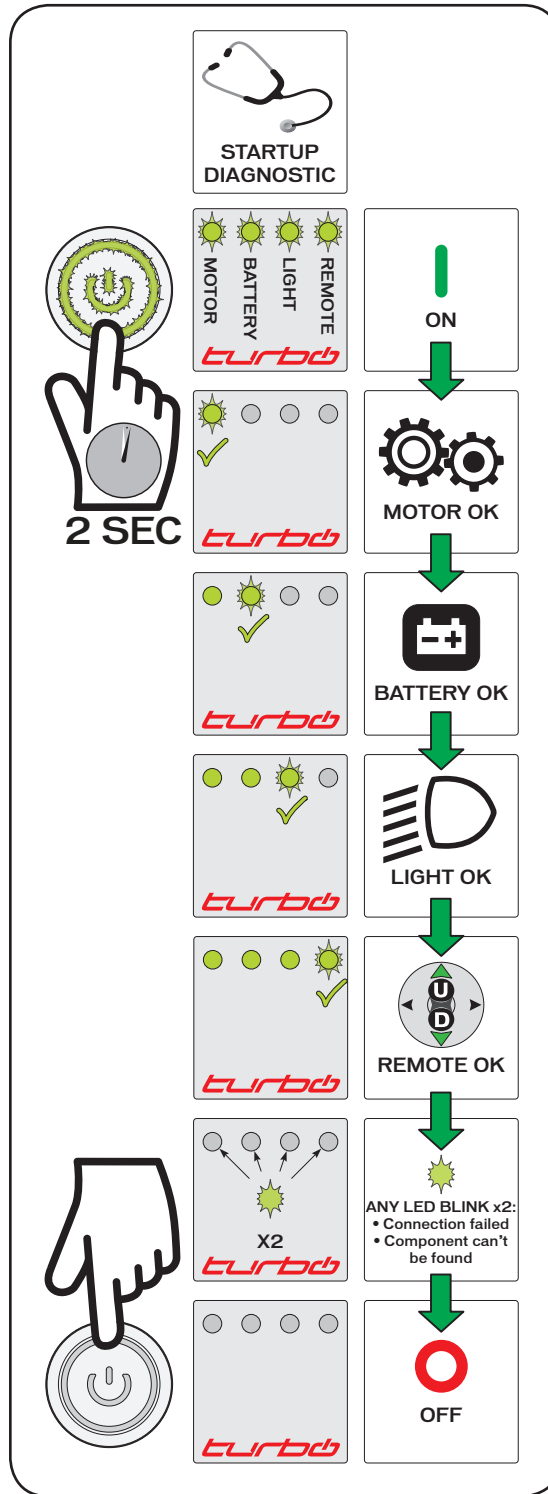

Checking the battery diagnostic



-  **WARNING!** Before you ride the bicycle, please familiarize yourself with the behavior and operation of the bicycle in a quiet, safe place.
-  **WARNING!** The battery is heavy, so please ensure that you do not drop it as this could cause injury and/or damage to the battery.
-  **WARNING!** Remove the key before riding. Otherwise, you may injure yourself on the protruding key, lose the key or the battery could become loose and fall out. This could result in accidents and injury.
-  **WARNING!** To prevent an uncontrolled launch, the system only starts to support you when the rear wheel is turning. Nevertheless, for your safety you should always have one brake applied before you place your foot on the pedal. Please also note that the speed switch provides strong support. This might feel very unusual. Uncontrolled launches with your bicycle can lead to a fall or serious accidents, particularly on loose or skiddy surfaces or in road traffic. Refer to local laws regarding wearing a bicycle helmet while riding (for example, helmet standard AS/NZS 2063).

2. SPECIALIZED TURBO COMPONENTS

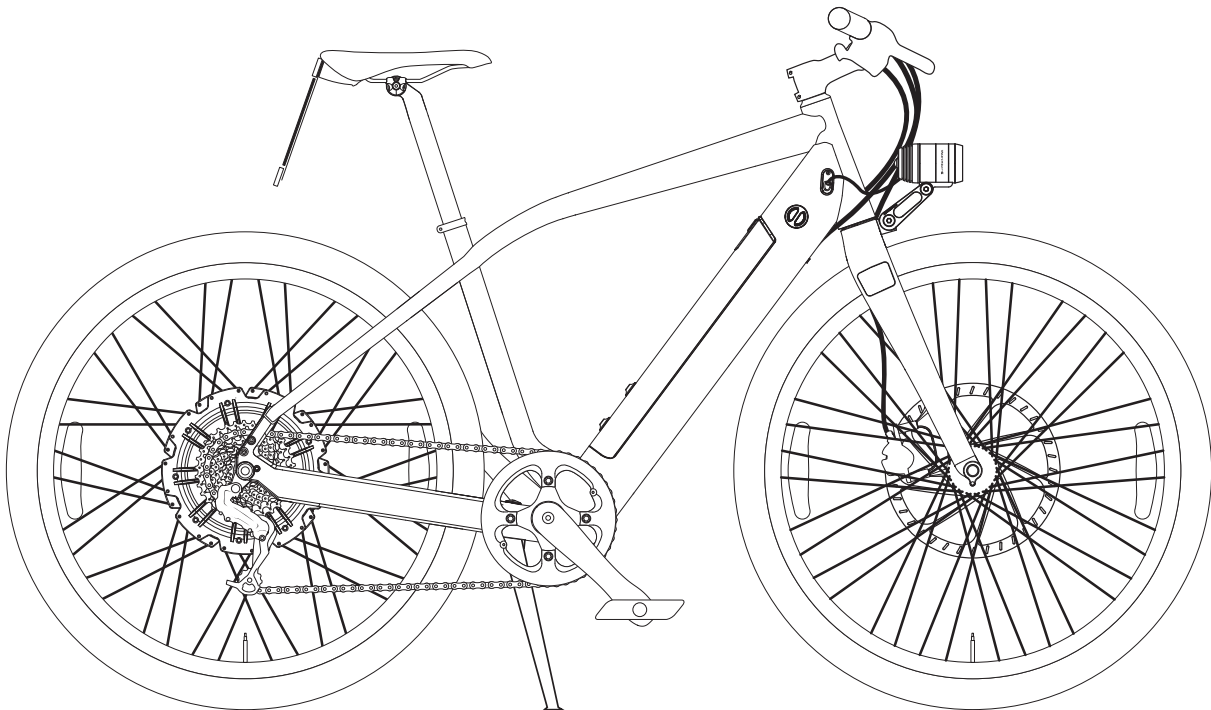
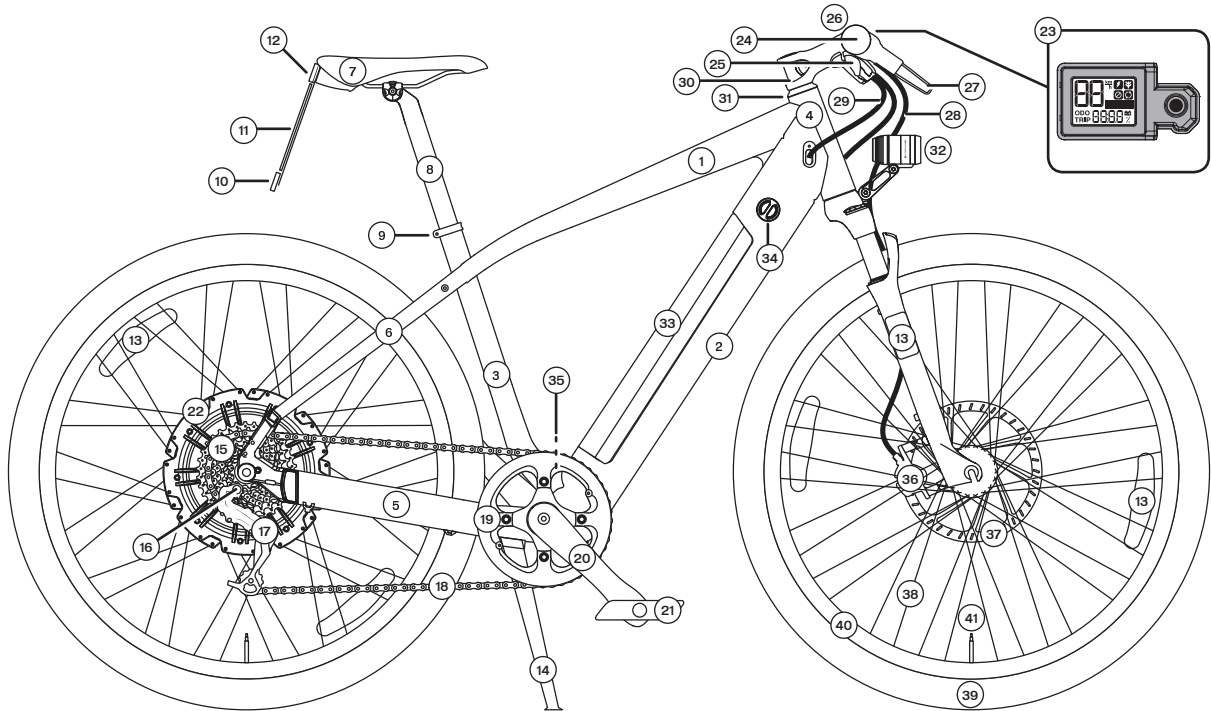

- | | | | |
|-------------------------------|-------------------------|---|--|
| 1. Top tube | 12. Rear light | 23. Screen / joystick (page 14) | 34. Charging socket and magnetic rubber plug (page 10 , page 12) |
| 2. Down tube | 13. Reflector | 24. Handlebar with grip | 35. Battery lock (page 11) |
| 3. Seat tube | 14. Kickstand | 25. Shifter | 36. Disc brake caliper |
| 4. Head tube | 15. Derailleur cassette | 26. Bell | 37. Brake disc |
| 5. Chain stay | 16. Dropout | 27. Brake lever | 38. Spoke |
| 6. Seat stay | 17. Rear derailleur | 28. Brake cable | 39. Tire (page 26) |
| 7. Seat | 18. Chain | 29. Shifter cable | 40. Rim |
| 8. Seatpost | 19. Chainring | 30. Stem | 41. Valve |
| 9. Seatpost clamp | 20. Crank arm | 31. Stem bearing or headset | |
| 10. Rear Integrated reflector | 21. Pedal | 32. Front light (page 20) | |
| 11. Rear licence plate | 22. Motor | 33. Battery (page 10) | |

3. EG - DECLARATION OF CONFORMITY



The manufacturer:

Specialized Bicycle Components Inc.

15130 Concord Circle

Morgan Hill, CA 95037, USA

Tel: +1 408 779-6229

hereby confirms for the product:

Product designation:

Specialized Turbo

Type designation:

Turbo or Turbo X

Year of construction:

2014

The conformity with all applicable directives from the guideline:

Machines (2006/42/EG).

The machine also conforms to all the directives in the guideline:

Electromagnetic compatibility (2004/108/EG).

The following harmonising norms were applied to the product:

DIN EN 15194: Bicycles - electrically power assisted cycles - EPAC bicycles.

DIN EN 14764: City and trekking bicycles. Safety requirements and testing procedure.

Technical documentation by:

Specialized Europe GmbH

Lorzenparkstrasse 10

6330 Cham, Switzerland

Philipp Möller

(Manager Legal and Logistics)

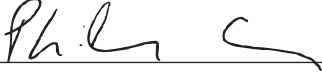
Signature: 

Jan Talavasek

(European Engineering Manager)

Signature: 

Specialized Europe GmbH

6330 Cham, Switzerland

July 1st, 2014

4. INTRODUCTION

Dear Customer,

We'd like to provide you with some important information about your new bicycle. This will help you make the most of it and avoid any possible risks. Please read this instruction manual carefully and keep it for future reference.

Your bicycle was fully assembled before you received it. If this was not the case, please contact your Authorized Specialized Dealer to ensure that this important work is completed.

Users of this product should have a basic and sufficient knowledge of how to use bicycles.

Everyone who uses, repairs, services, cleans or disposes of this bicycle must understand and take note of the content and purpose of this instruction manual. If you have any questions or you are not clear on certain points, you should contact your Authorized Specialized Dealer for your own safety.

All information in this instruction manual relates to the construction, technology as well as care and servicing of your bicycle. Please take notice of this information as much of it is relevant to your safety - failure to follow it can result in serious accidents and damage.

This instruction manual only applies to the bicycle with which it was supplied.

For more specific technical details, please refer to the enclosed notes and instructions from the respective manufacturers of the individual components used on the bicycle. If you are unsure about a particular point, please contact your Authorized Specialized Dealer.

Before riding your electric bicycle, please check your local laws related to bicycles and electric bicycles. If you are unsure as to where to refer to your local laws, please refer to your Authorized Specialized Dealer. Applicable laws may include laws related to the following, without limitation, and which are examples only:

- Where you may or may not ride your bicycle.
- Whether you must register to electric bicycle.
- Whether you must have a driver's license to operate your bicycle.
- Whether and what type of helmet you must wear to operate your bicycle.
- The required age for riding an electric bicycle.

Important points for rider safety:

- Always wear a suitable helmet adjusted to fit your head and wear it for every ride!
- Read the instructions supplied by your helmet manufacturer relating to fitting the helmet properly.
- Always wear bright clothing or sportswear with reflective elements when you ride. This is vital to ensure you are SEEN.
- Always wear tight clothing on your lower body, and trouser clips if required. This prevents any loose items of clothing from snagging and leading to possible injury. Your shoes should be grippy and have stiff soles.

 Even if you are an experienced bicycle user, please take the time to first read the chapter "Before the first ride" and then carry out all the important checks from the chapter "Before each ride".

Please note that as a cyclist, you are particularly at risk on public roads. Ensure that you protect yourself and others with responsible and safe riding!

When in the 45 km/h max speed setting, the Turbo is referred to as an L1e S-Pedelec or speed Pedelec. When in the 25 km/h max speed setting, it's referred to simply as a bicycle or Pedelec.

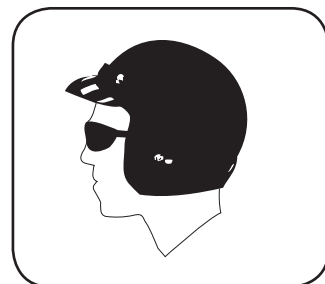

5. SAFETY INFORMATION

Please carefully read all warnings and notes in this instruction manual before using the bicycle. We recommend keeping the manual close to your bicycle, so that it is always at hand.

Please ensure you read the chapters "Before the first ride" and "Before each ride" before using the bicycle for the first time.

If you lend your bicycle to a third party, please give them this instruction manual with the bicycle with the request to read it before the first ride.

This operating manual contains different types of pointers - one providing important information about your new bicycle and how to use it, a second referring to possible damage to property and the environment, and a third type warning against potential falls and serious damage, including physical injury.

If you see one of the symbols below, there is always a risk that the danger described can occur.

 **INFO:** This symbol provides information about how to use the product or highlights specific parts of the instruction manual that are particularly important.

 **CAUTION:** This symbol is aimed at warning you against improper use that could result in damage to the bicycle, property or the environment.

 **WARNING!** This symbol indicates possible dangers to your health and life if specific actions are not undertaken or corresponding care is not taken.

 **Important bolted connection!** Please adhere to the exact recommended torque when tightening this connection. The correct mounting torque is either displayed on the component or listed in the table of torques on [page 23](#). A torque wrench has to be used to achieve the precise prescribed torque. If you don't own a torque wrench then you should always leave this work up to your Authorized Specialized Dealer. Parts which do not have the correct torque could fall off or break. This can result in serious accidents.

Regularly check that the bolts and components are secure.

 **WARNING!** Modern bicycle technology requires expert knowledge, experience and Specialized authorized tools. Please do not attempt to work on the bicycle yourself. Give your bicycle to your Authorized Specialized Dealer for repair, servicing and maintenance.

6. BEFORE THE FIRST RIDE

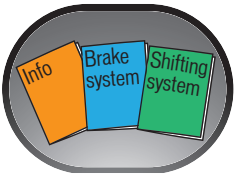

Before your first ride, please consult the instruction manuals of the individual component manufacturers, which were supplied with your bicycle or are available online.

Please fully charge the battery before the first use. During the charging process, the diode on the charger will glow red. When the battery is fully charged, the diode on the charger will turn green. The battery can now be put to use.

Your Authorized Specialized Dealer will be happy to answer any further questions you have after reading this manual. Please ensure that your bicycle is ready for use and is adjusted to fit your body.

Fit: Please ensure that your bicycle is ready for use and is adjusted to fit your body, including:

- Setting the position and fixture of the seat and handlebar
- Checking the assembly and settings of the brakes
- Securing the wheels into the frame and fork
- Checking the tire pressure
- Checking that battery is properly secured

To ensure that you enjoy a safe and comfortable riding position, please allow your Authorized Specialized Dealer to set up your handlebar and stem.

Adjust the seat to a safe and comfortable position for you (please refer to your Specialized Bicycle Owner's Manual).

Allow your Authorized Specialized Dealer to set up the brakes so that the brake levers are always within easy reach. Ensure that you know which lever operates which brake (right/left).

 **WARNING!** Before you switch the system on, ensure that the cover of the magnetic rubber plug is attached to the frame. The contacts below it are live with electricity when the system is switched on.

 **WARNING!** Modern braking systems are powerful. Please take an initial test ride to familiarize yourself with the brakes in a safe, open space before setting off on your first ride with the bicycle. Also remember that the effectiveness of brakes can be different in wet conditions or on slippery surfaces. Please take into account the possibility of longer braking distances and slippery surfaces when riding.

 Practice operating and riding your bicycle in a quiet and safe place before regular riding.

 Ensure that the wheels are securely fastened in the frame and fork. Check that the wheels and thru axles as well as all important nuts and bolts are secure (see [page 23](#)).

Lift your bicycle up slightly and drop it onto the ground from about 4" (10cm) in the air. If it rattles or makes any unusual noise, please ask your Authorized Specialized Dealer to identify and fix the problem before you ride.

Push the wheels forward with the brakes pulled. The back brake should completely prevent the back wheel from moving, while the front brake should lift the back wheel off the ground with its braking effect. The bicycle's steering should not rattle under braking or exhibit any play.

Check the air pressure in the tires. You will find instructions as to the correct tire pressures on the sides of the tires. Please adhere to the required minimum and maximum pressure. If you cannot find any recommended pressures, 45 PSI is a suitable pressure for most tires. If the tires are narrow, 60 PSI is suitable.

As a general rule of thumb, e.g. on a ride, you can check the tire pressure as follows: If you place your thumb on a pumped up tire, you should not be able to significantly change its shape by applying pressure.

Check the tires and rims. Scan them for any damage, cracks or deformations, as well as embedded particles, e.g. shards of glass or sharp stones.

If you should find any cuts, rips or holes in the tires, please refrain from riding. First have your bicycle checked over by your Authorized Specialized Dealer.

7. BEFORE EACH RIDE

Before each ride, please check that:

- The bell and lights are working and are properly secured
- The brakes are working safely and are properly secured
- The housings and fittings of the hydraulic brakes are not leaking
- The tires are free of foreign objects and damage, and the wheels run true
- The battery is properly secured
- The tires have sufficient tread depth
- All bolts and nuts are tight (see [page 23](#)). Check that all quick releases are still correctly secured whenever the bicycle was left unattended, even for a short time
- The frame and fork are not damaged
- The handlebar and stem are correctly and securely fastened as well as set up in the correct position
- The seatpost and seat are secure and in the correct position. Try turning the seat or tipping it upwards or downwards. It should not move
- If you are using clipless/magnet pedals, please check that they are working properly. The pedals should release easily and smoothly

 **WARNING!** Before you switch the system on, ensure that the magnetic rubber plug is attached to the frame. The contacts below it are live with electricity when the system is switched on.

 **WARNING!** If you are unsure of whether your bicycle is in a sound technical condition, take it to your Authorized Specialized Dealer to be checked instead of riding it.

It is particularly important if you use your bicycle a lot, either through sports riding or daily use, that you regularly have all the important parts checked by your Authorized Specialized Dealer (see service schedule on [page 27](#)).

Frame, fork and other parts relevant to your safety such as brakes and wheels are subject to heavy wear which can impact the operating safety of these parts.

If you use parts for longer than their intended lifetime, they can fail without warning. This can lead to falls and serious injury.

 In the event of a fall or if your bicycle falls over, please perform the checks outlined on [page 8](#) before continuing to ride. In cases like this, it is recommended to have your bicycle checked by your Authorized Specialized Dealer before you continue your ride.

Aluminum parts cannot be safely bent back into shape, and carbon components can sustain damage which is not visible to the eye.

8. LEGAL REGULATIONS

 **WARNING! YOUR INSURANCE POLICIES MAY NOT PROVIDE COVERAGE FOR ACCIDENTS INVOLVING THE USE OF THIS BICYCLE. TO DETERMINE IF COVERAGE IS PROVIDED YOU SHOULD CONTACT YOUR INSURANCE COMPANY OR AGENT.**

Before riding your electric bicycle, please check your local laws related to bicycles and electric bicycles. If you are unsure as to where to refer to your local laws, please refer to your Authorized Specialized Dealer. Applicable laws may include laws related to the following, without limitation, and which are examples only:

- Where you may or may not ride your bicycle;
- Whether you must register your electric bicycle;
- Whether you must have a driver's license to operate your bicycle;
- Whether and what type of helmet you must wear to operate your bicycle;
- The required age for riding an electric bicycle.



 Any changes to the bicycle not approved by Specialized, have the following effects:

- Nullifying the warranty requirements on the manufacturer's side
- Possible changes to the insurance obligations
- Possible changes to the applicability of the local laws to the electric bicycle

A. Intended use

 **WARNING!** This electric bicycle is intended for transporting one person at a time. Fit your bicycle with suitable equipment if you would like to transport luggage. Ensure that you do not exceed the maximum permissible weight of 295 lb (134 kg) (see [page 23](#)).

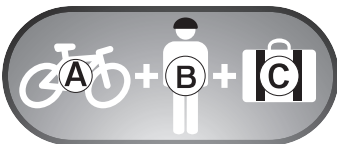

Permitted weight: Bicycle weight (A) + Rider's weight (B) + Baggage weight (excluding trailers) (C).

Using the bicycle as intended also means adhering to the operating, maintenance and upkeep conditions described in this manual.

The manufacturer and dealer do not assume any liability for activities above and beyond the intended use. This particularly applies for not adhering to safety advice and damage resulting from this, for instance: off-road use, carrying excess weight or making improper repairs to defects.

The electric bicycle is not generally designed to withstand extreme stress, such as riding down steps or over jumps.

9. BATTERY

i Please read the instructions relating to the battery before using the bicycle for the first time.

i Check the battery before using the bicycle for the first time.

i Never charge a battery which you suspect is damaged or know is broken, and do not use it.

Your bicycle is powered by a modern lithium ion (Li-ion) battery (fig.1). They offer a large capacity (range) with the lowest weight. In addition, they do not suffer from memory effect.

Your battery is protected by a modern management system against overcharging and short-circuits.

There are six contacts in the charging socket of the battery.

If a short-circuit is caused by connecting the contacts, the management system is able to switch off the battery within 2 milliseconds. This effectively avoids any hazard to the user.

Fig.2: The shape of the charging socket has been designed in such a way that the magnetic rubber plug and charging plug can only be inserted in the correct position.

i You can achieve the best possible performance and lifespan of your battery by charging on a regular basis and using it within the recommended temperature range. The battery has almost no memory effect thanks to the Li-ion technology.

The charge level of the battery is permanently displayed during your ride. The green LEDs on the battery glow depending on how full your battery is. The computer screen also displays the battery charge.

If the battery charge falls to 20% during a longer ride, the battery management system (BMS) automatically switches to Eco mode. If you continue to ride with support, the system will switch off before the battery runs out.

i Please recharge an empty battery as soon as you have a chance to. The BMS is set up to protect a fully discharged battery from damage for a long period of time. However, we recommend to recharge at least up to ¾ (3 diodes full) when bicycle or battery is not in use. In any case, please charge at least every 3 months to avoid damage to the battery. A dead battery due to not charging the battery is not a warranty claim.

i At 3% battery charge or lower, the electric bicycle switches the motor off, only the lights will still work. At this point, the lights on your bicycle will work for approximately 2 hours.

If your bicycle does not move for a 10 minute period, the BMS will switch the system off. In order to continue driving with support, you have to switch the system on again.

i Every battery with Li-ion technology is subject to an unstoppable chemical ageing process. Provided the bicycle has been used properly, remaining capacity of 75% will remain after 300 charging cycles or two years.

Strongly reduced operating time after charging can be a sign that the battery is running out and has to be replaced.

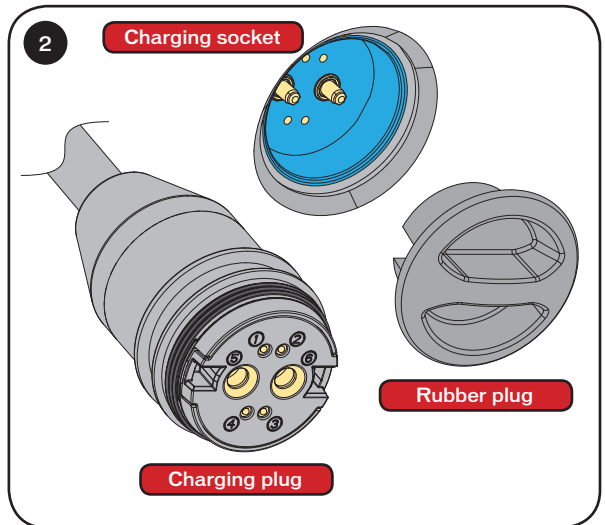
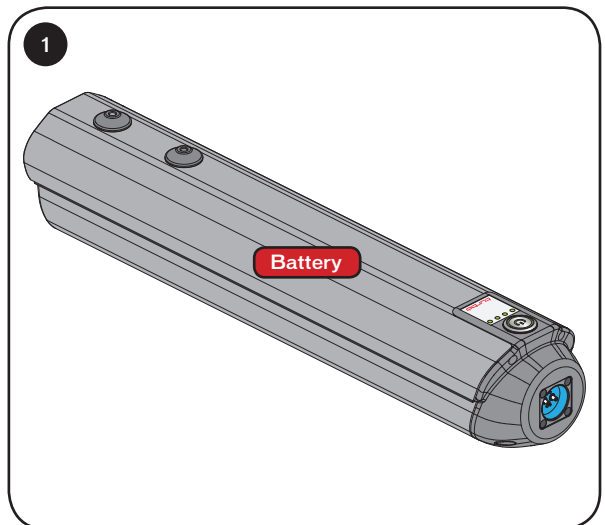

A. Battery information system

The bicycle's battery can inform you about the charge level and the functionality of the electrical system.

After turning the system on, a diagnosis of the entire system is first carried out (fig.3).

Four LEDs switch on in sequence and then remain on. This checks the connection of the management program to the individual components in the system.

It shows:

- LED 1: connection to the motor
- LED 2: connection to the battery
- LED 3: connection to the lights
- LED 4: connection to the remote

If one of the LEDs flashes, this shows that the BMS has not found one of the respective components. This could mean that the component is not connected (e.g. the remote, which is located on the right handlebar), or that there is a fault. To resolve the error, first check all plug connections and remove the battery from your bicycle (fig.5 & 6), and then reinstall it (fig.7). Repeat the process of turning your bicycle on as described in section 12.F. If the bicycle works normally despite a flashing LED, you are still able to use your bicycle with support. However, you should find your Authorized Specialized Dealer in order to find the cause of the flashing LED.

B. Charge level display

Once the diagnosis is complete (fig.3), the charge level of the battery is permanently displayed during your ride (fig.4). The green LEDs glow depending on the charge level of your battery.

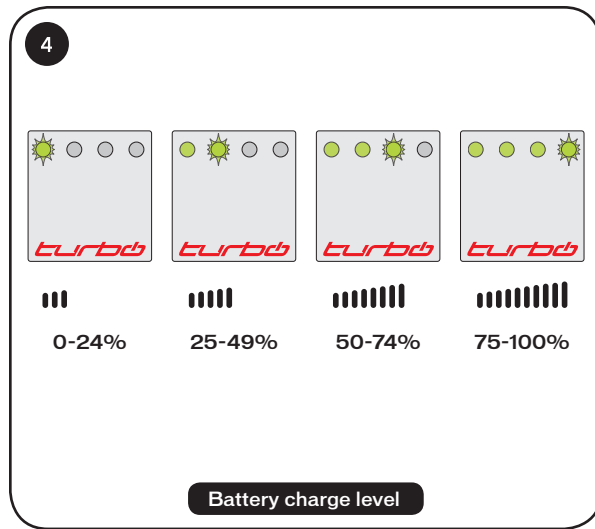
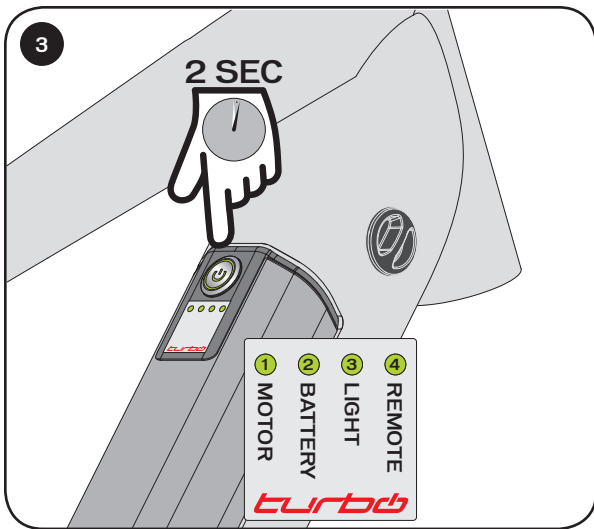

C. Range

The range of the battery can vary considerably depending on the model/capacity of the battery and various conditions such as the gradient of your route and the support mode.

D. Removal / Installation

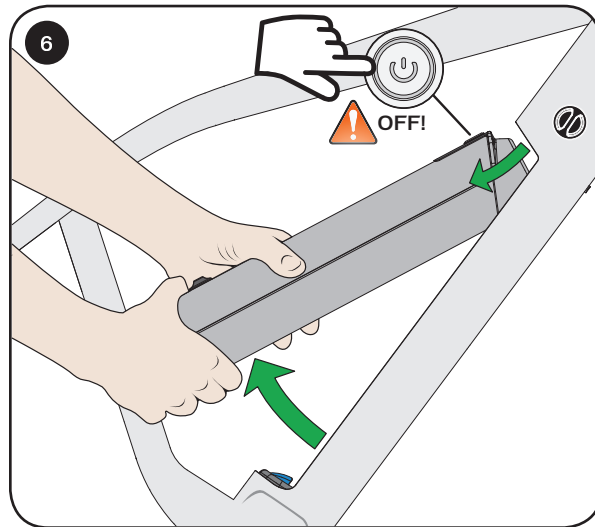
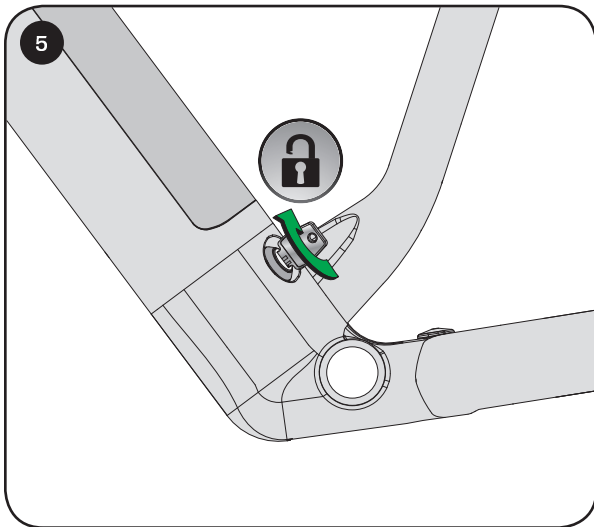

To remove the battery:

1. Make sure the battery is turned off!
2. Insert the key into the lock, turn clockwise and hold (fig.5).
3. While holding the key in the clockwise position, with the other hand, pull up on the battery to disengage it from the latch.
4. Let go of the key and with both hands, pull up from the base of the battery, then disengage the top (nose) of the battery from the frame (fig.6).

To install the battery:

1. Make sure the battery is turned off!
2. Using both hands, insert the top (nose) of the battery into the upper section of the down tube (fig.7).
3. Lower the bottom of the battery into the cavity, until the latch engages the battery. When the battery is engaged, there is an audible click.

WARNING! The battery is very heavy. Please ensure that you do not drop it as this could cause injury and/or damage to the battery.

WARNING! Remove the key before riding. Otherwise, you may injure yourself on the protruding key, lose the key or the battery could become loose and fall out. This could result in accidents and injury.

E. Cleaning

Please always remove the battery from your bicycle before cleaning your bicycle.

Please only wipe the battery with a cloth. Avoid the battery coming into contact with water. This can lead to the battery switching itself off for safety reasons. The battery has to be switched off before cleaning.

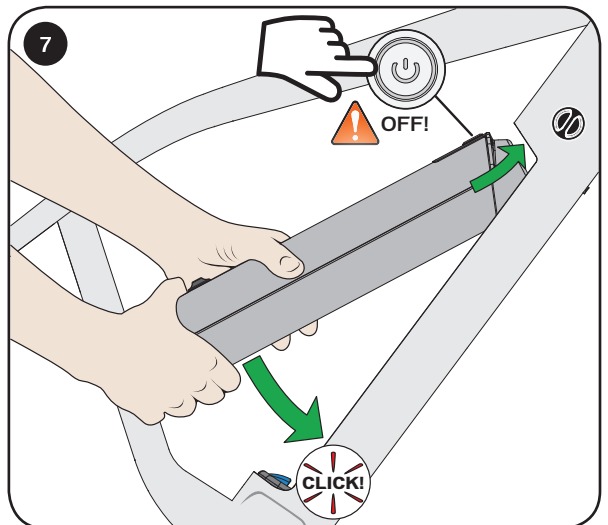

i Never use a high-pressure cleaner when cleaning your bicycle. You can use conventional products from a bicycle shop for all cleaning processes. Please ensure that no water comes into contact with the electronic components while washing.

F. Storage

Charge the battery in a dry place and ensure that there is sufficient ventilation. Please store the battery at room temperature and charge until three-quarter full. You can check the charge level by looking at the battery when it is switched on. Three-quarter charge corresponds to 3 green diodes.

i If you do not use the battery for a long period of time, you should charge it at least every three months.

If you do not load the battery over a period longer than three months, this can lead to a completely flat battery and therefore damage the battery.

i Before you store the bicycle, ensure that the battery is switched off and the cover of the magnetic rubber plug is inserted into the frame. The contacts below it are live with electricity when the system is switched on.

We do not recommend leaving the battery charging with the charger while storing the bicycle.

G. Transport

Your bicycle's battery contains energy of >100Wh. Batteries with energy >100Wh are subject to the Dangerous Goods Legislation. The battery used contains Li-ion cells which are classified as a class 9 dangerous material. Transporting it in a plane or shipping it by land, water or air requires special prior approval.

If you want to ship the battery or your bicycle, please consult your Authorized Specialized Dealer first as well as the transport company in order to find out which precautionary measures you have to take. The consultation of an expert for hazardous materials prior to transport is absolutely required.

i If you want to transport your bicycle by car, please remove the battery before transport and carry the battery separately. Specialized recommends using the UN approved Specialized Turbo battery transport box supplied with your Turbo bicycle. The rubber cap needs to be installed on the battery's charge port during transport (fig.12).

H. Disposal

Used batteries should not be thrown in the domestic waste.

You can return used batteries to a recycling facility or to your Authorized Specialized Dealer.

Defective or used batteries, battery packs or single cells must be collected separately and disposed of in an environmentally friendly manner.

LI-ION According to directive 2006/66/EC of the European Parliament, defective or used batteries, battery packs or single cells must be collected separately and disposed of in an environmentally friendly manner.

i Please inform yourself about the applicable national regulations in your specific state.

10. CHARGER

i Please read the instructions relating to the charger before using it for the first time. The operating voltage is 100-240 V.

! **WARNING!** Please only use the Specialized charger supplied with the bicycle or other chargers approved by Specialized. Check the charger before every use for possible damage to the charger itself, the cable or the plug: Never use a charger which you suspect is damaged or know is broken.

During the charging process, the diode on the charger will glow red. When the battery is fully charged, the diode on the charger will turn green. The battery can now be put to use (fig.8, 9).

Charge the battery in a dry place and ensure there is sufficient ventilation. Do not allow the charger to come into contact with rain, water or moisture. Neither the battery nor the charger should be covered during the charging process. Please ensure that you do not have any flammable or dangerous substances in the charging room. Place the charger in a stable position so that it cannot fall over. When cleaning the charger, always first unplug the device.

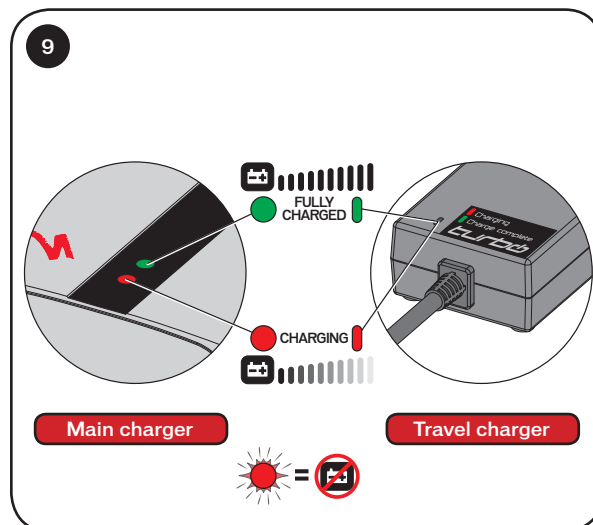
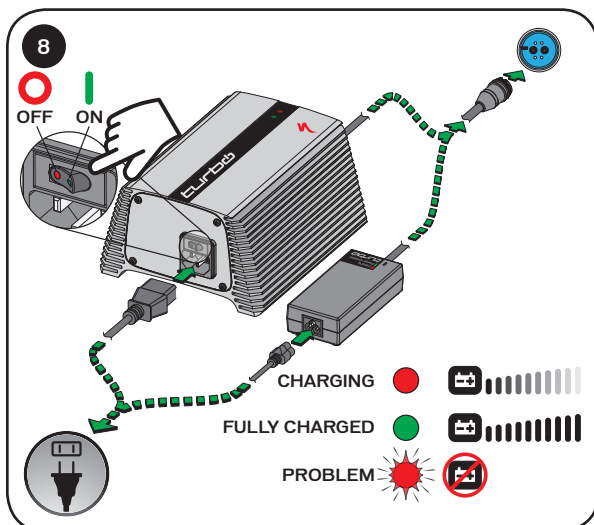

WARNING! If the red LED flashes during the charging process, a charging error has occurred. If this is the case, please remove the charger from the socket immediately and contact your Authorized Specialized Dealer to identify the fault. In this case, the bicycle, battery and the charger may no longer be used. However, you are permitted to use it as a conventional bicycle without electrical support.

A. Charging process

To charge the battery, you don't have to take it out of the bicycle (fig.11). To do this, remove the **magnetic rubber plug** in the top right of the frame. In order to ensure the best possible charging results, in the event of cold conditions, please remove the battery from the bicycle and charge it in a warm room (fig.12).

Please charge the battery in temperatures between 32°F (0°C) and 122°F (50°C) (fig.10). At temperatures outside this range, you can damage the battery which can lead to a loss of performance.

10

turbob Li-Ion		ATTENTION		DO NOT		TEMPERATURE RANGE		ANGER			
MODEL	SBC-B03	Charge at least every 3 months, even when the bicycle is not in use.		<ul style="list-style-type: none"> • Only use the approved Specialized charger to charge this battery. • Only use this battery with the appropriate Specialized bicycles. • Do not store in direct sunlight or in places (such as inside cars) where the heat can become excessive. Keep away from heat and open flames. Store in a cool, dry, well-ventilated place. • Do not expose the battery to excessive physical shock or vibration. • Do not charge the battery in temperatures below 30°F or above 120°F. 		<ul style="list-style-type: none"> • Do not modify or disassemble the battery. • Do not store the battery on a metal shelf. Do not connect and do not allow a metal object, such as a wire, to contact both the (+) and (-) terminals. • Do not store or carry the battery with metal parts like balloons, rock-bands, etc. • Do not puncture, crush or otherwise damage the battery. • Do not charge the battery in temperatures below 30°F or above 120°F. 		<ul style="list-style-type: none"> 32°F - 122°F / 0°C - 50°C Charging temperature -4°F - 158°F / 0°C - 50°C Discharging temperature < 95°F / < 35°C Storage temperature 		NOT FOLLOWING THESE INSTRUCTIONS CAN CAUSE HEAT, FIRE AND EXPLOSION AND CAN RESULT IN SERIOUS INJURY OR DEATH <small>This battery must be disposed of properly.</small>	
VOLTAGE	36 V	If internal materials leak from the battery, avoid any contact with such materials, and immediately dispose of the battery and leaking contents as industrial waste as required by law.									
CAPACITY	13Ah/468Wh										

You can attach the charging plug directly into the charging socket in the frame. The plug is held in place magnetically. Due to the special shape of the charging socket and effective placement of two magnets, we ensure that the charging plug can only be connected to the socket in the correct position. The magnetic rubber plug can be attached to the down tube (fig.11) when the battery is being charged.

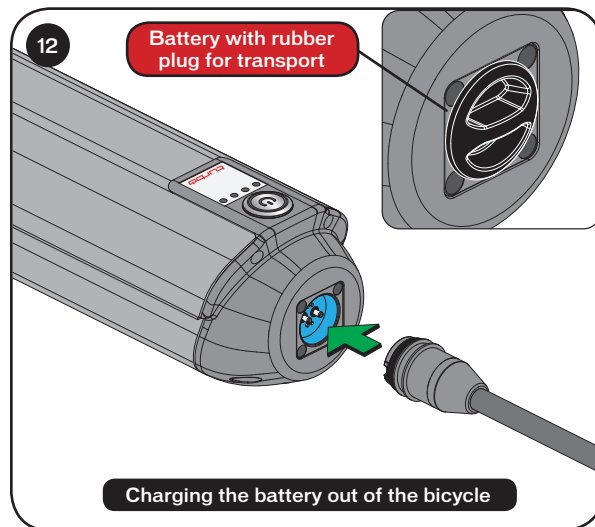
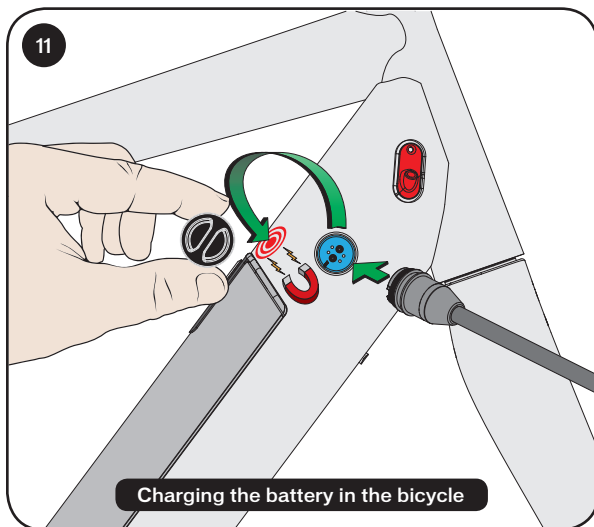

Charge the battery in a dry and warm place, between 32°F (0°C) and 122°F (50°C). Please also ensure that there is sufficient ventilation. The heat created during the charging process has to be able to escape from the charger. Please only use the original Specialized charger or travel charger.

! Please only use the Specialized charger supplied with the bicycle or other chargers approved by Specialized. Check the charger before every use for possible damage to the charger itself, the cable or the plug: Never use a charger which you suspect is damaged or know is broken.

Please read the sticker on the battery before using.

Place the charger and the battery on a level, non-flammable surface. Plug the charger's plug into an outlet (100 - 240V), using the appropriate plug for the country's standards. Then connect the charging plug with the charging socket on the battery. Refer to fig.2 & 8.

While the battery loads, the red LED on the supplied charger or the optionally available travel charger glows red and the green LEDs on the battery flash (the number of LEDs flashing will increase as the charge level in the battery increases). When the battery is fully charged, the green LED on the charger glows green, and the green LEDs on the battery turn off (refer to fig.8 & 9 on page 12).

BATTERY	SBC-B01		SBC-B02		SBC-B03	
CHARGER	SBC-C03	SBC-C02	SBC-C03	SBC-C02	SBC-C03	SBC-C02
CHARGE TIME	2.5h	5h	3.5h	7h	3.3h	6.5h

After completing the charging process, the charger can remain connected to the battery without the danger of overcharging. However, we advise separating the charger and the battery after successfully completing the charging process as this saves electricity.

B. Cleaning

The charger has to be switched off and separated from the battery before cleaning. Clean the ventilation grills if necessary with a dry cloth or a vacuum cleaner.

C. Disposal

Used chargers should not be disposed of with domestic waste.

You can return used batteries to a recycling facility or to your Authorized Specialized Dealer.

Defective or chargers no longer in use, must be collected separately and disposed of in an environmentally friendly manner.

In the EU, consumers have a legal obligation to return defective, unused or non-functioning chargers, while dealers, manufacturers and importers have an obligation to accept them. You can return used batteries to a recycling facility or to your Authorized Specialized Dealer.

 According to directive 2002/96/EC of the European Parliament on waste electrical and electronic equipment (WEEE), defective or chargers no longer in use, must be collect separately and disposed of in an environmentally friendly manner.

 Please inform yourself about the applicable regulations in your specific state.

11. USER INTERFACE

A. Turbo cyclocomputer functions

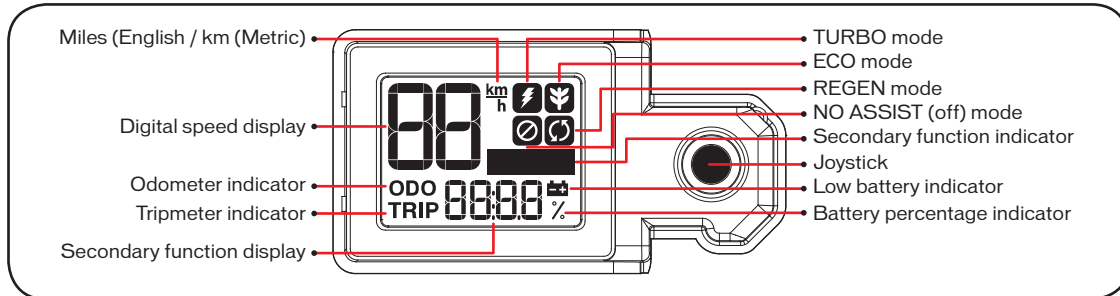

B. Joystick functions

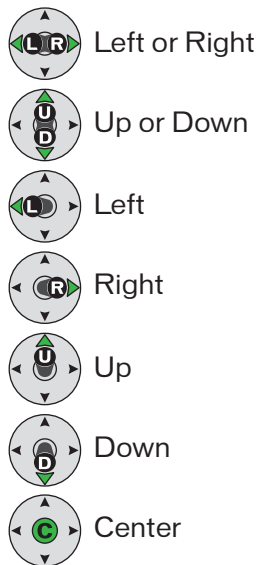

C. Screen setup

- To access the setup function of the computer: Press and hold the joystick to the left while squeezing the right-side brake lever. Press the battery power button to turn on the system, then continue to hold the joystick to the left and the brake lever closed for 3 seconds.

SET UNIT (km/h or mph)

0 sec | 10 sec

km/h (kilometers) | mph (miles)

- Set unit:** Press the joystick left or right to choose the desired unit (km/h or mph), then press the joystick down (center).

SET BACKLIGHT (yes or no)

BL Y | BL N

Backlight permanent | Backlight 5 seconds

- Set backlight:** Press the joystick left or right to choose the desired setting (backlight always on or 5 seconds), then press the joystick down (center).

TEMPERATURE / VERSION TEST

5 sec

TEMP 77F | VER 01

Temperature (mph=F) | Software version

TEMP 25C

Temperature (km/h=C)

5 sec

- Battery temperature / software version test:** Press the joystick to the left for 5 seconds.
 - Press the joystick to the right to switch between the temperature and the software version.
 - Press the joystick to the left for 5 seconds to exit the test screen.

BATTERY VIEW OPTIONS

OR

Normal view | Low battery view

- Battery view options:** The screen will display the battery charge percentage until it drops below 20%, then it'll also show the battery symbol.

RESET TRIP MODE

10 km/h | TRIP 73.1

3 sec

10 km/h | TRIP 0

Trip mode | Reset trip mode

- Reset trip mode:** When in TRIP mode, hold the joystick to the right for 3 seconds to reset. The TRIP mode will reset itself automatically after the battery is charged.

ECO % +/- ADJUST

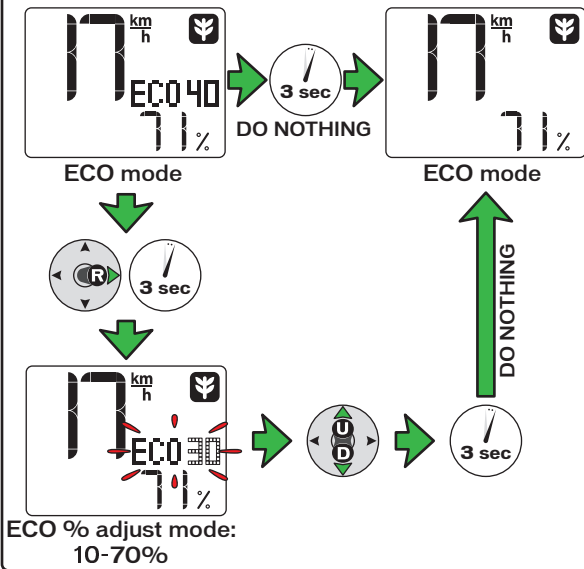

- **Set ECO level:** When the speed setting is in ECO mode, the ECO # will be displayed.
 - If nothing is done for 3 seconds, the ECO # disappears.
 - With the ECO # visible, if the joystick is held to the right for 3 seconds, the ECO # will start to flash. While flashing, the percentage of ECO assistance can be adjusted between 10 and 70%.
 - When the ECO # is flashing, if nothing is done for 3 seconds, the ECO # will disappear.

MODE OPTIONS

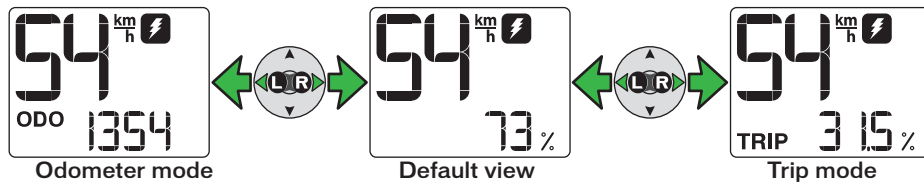

- **Mode options:** To switch between ODO mode, TRIP mode or default view, press the joystick to the left or right.

TRAVEL MODE OPTIONS

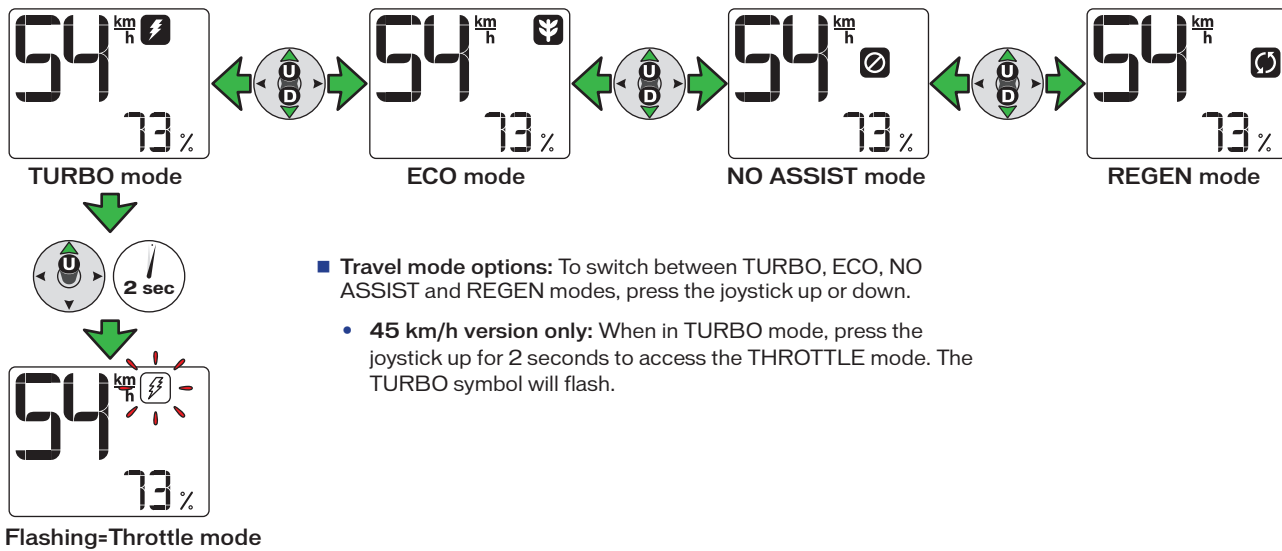

- **Travel mode options:** To switch between TURBO, ECO, NO ASSIST and REGEN modes, press the joystick up or down.
 - **45 km/h version only:** When in TURBO mode, press the joystick up for 2 seconds to access the THROTTLE mode. The TURBO symbol will flash.

E. Motor/support

- The bicycle motor provides nominal power of 200 watts.
- You can use the support with two different drive settings (TURBO and ECO). In addition, there is also a regeneration (REGEN) setting.
- The various modes are managed using the joystick (**fig.13**) to the right of the screen, on the right-hand side of the handlebar.
- To switch into a stronger support mode, press the joystick UP. To switch into a weaker support mode, press the joystick DOWN. After reaching the strongest or weakest mode, the system will not continue to switch. To reduce from TURBO to REGEN, you have to press the joystick DOWN. To increase from REGEN to TURBO, you have to press the joystick UP.

 **WARNING!** It is possible to achieve substantially higher speeds on the Turbo than with a normal bicycle, due to the support provided by the electric bicycle's motor. This might feel very unusual. Therefore it is important to practice riding the electric bicycle

The 45 km/h (28 mph) version Turbo bicycle is only permitted in certain countries and may be subject to individual country's legal regulations and requirements. Before riding your electric bicycle, please check your local laws related to bicycles and electric bicycles. If you are unsure as to where to refer to your local laws, please refer to your Authorized Specialized Dealer.

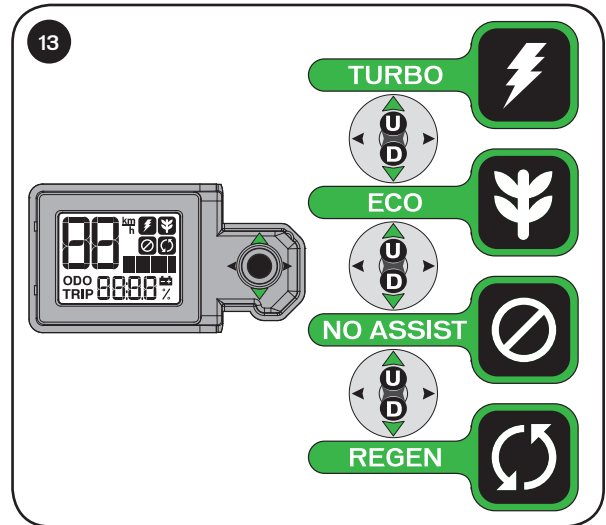

TURBO (25 km/h (15.5 mph) or 32 km/h (20 mph) Pedelec version):

- The motor, while pedaling, provides maximum support, up to a speed of 25 km/h (15.5 mph) or 32 km/h (20 mph), and then switches itself off.

TURBO (45 km/h (28 mph) S-Pedelec / USA version):

- The motor, while pedaling, provides maximum support, up to a speed of 45 km/h (28 mph), and then switches itself off.

On request, the bicycle support can be reduced to a maximum of 25 km/h (15.5 mph) by your Authorized Specialized Dealer. In this case, the vehicle is classified as a Pedelec and is subject to other rights and obligations. Among other things, helmet and insurance requirements may be affected depending on national laws. Please inform yourself about the applicable national regulations in your specific country before using your bicycle. It is also possible for your Authorized Specialized Dealer to switch the support back to 45 km/h.

THROTTLE mode (45 km/h (28 mph) version only, accessed from TURBO mode):

In "Throttle" mode, the bicycle is able to achieve speeds of up to 20 km/h (12.5 mph) solely by motor power.

In order to enter THROTTLE mode, first switch into TURBO mode then hold the joystick UP for two seconds or longer. In this mode, you can accelerate the bicycle by pressing and holding the joystick UP. To leave this mode, you have to apply the right brake lever for a short period or press the joystick DOWN. Then the motor switches to TURBO mode.

 When using THROTTLE mode, the motor provides full assist, which requires no pedaling. However, the available range from a fully charged battery is limited to a maximum of 30 to 60 minutes.

ECO:

- ECO mode means that the motor provides 10 to 70% of the maximum performance depending on the level set by the rider.

NO ASSIST:

- If the system is on but set to NO ASSIST (Off), the motor will not provide support.

REGEN:

In REGEN mode (regeneration/recovery), the motor acts as a generator, i.e. it is able to recover energy through its own motion. The REGEN mode slows the vehicle somewhat while charging the battery. The motor works very effectively in this mode and only slows the vehicle slightly. The amount of power recovered depends on length of time used. The REGEN mode is best used when riding downhill.

This process recharges the battery and therefore increases the possible range. In order to recover energy, the bicycle has to be set to REGEN mode. Energy recovery starts to take place by pressing the joystick DOWN to switch to REGEN mode.

F. Starting the system

- To start the system (**fig.14**), press the On/Off switch for two seconds. This is located in the middle of the top side of the battery.
- To switch the support off again, a short push on this button suffices. When the system is switched on, the button will glow with a green light.
- After switching the system on, a diagnosis of the system is first carried out.
- On start-up, the system always launches in TURBO mode.

The level of motor support in ECO mode can be tailored to your individual needs. Using the screen or with help from your Authorized Specialized Dealer, you can program the ECO mode so that you are supported with between 10 and 70% of the maximum motor performance. If you set up the ECO mode for lower support, this consumes less power and therefore allows a greater range. However, this also provides less propulsion power. Specialized recommends 30%, which is the factory setting of the bicycle.

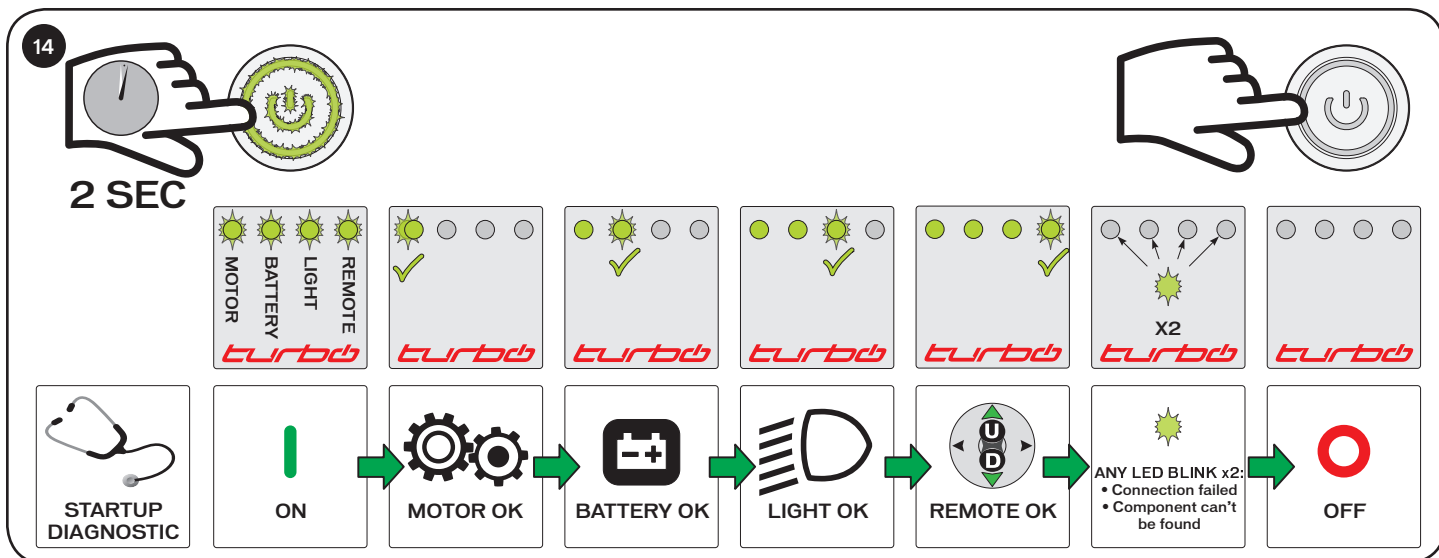

If the system is not functioning correctly, apply the steps below. If the system still does not work correctly, please take the bicycle to an Authorized Specialized Dealer.

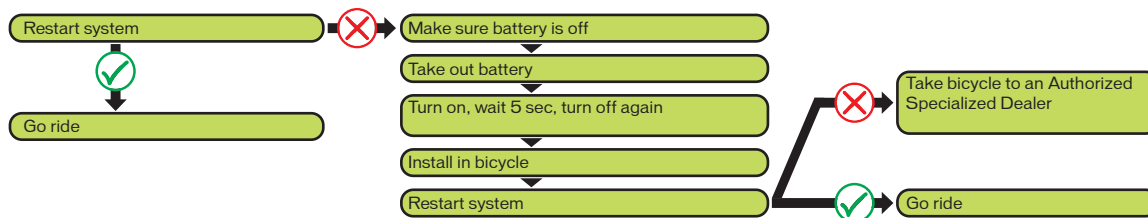

G. Error codes displayed

The BMS of the battery automatically checks the functionality of the system. If the system detects an error, the corresponding error message is displayed on the screen.

If you receive such an error, please restart the system. If the error message continues to be shown, please contact your Authorized Specialized Dealer for further instructions. Depending on the type of error message, the system may be switched off automatically. It is possible to continue riding with this system switched off without support from the motor, at any time.

Message displayed	Meaning	Solution
B-HOT	The battery is too hot	Please pull over and turn off the system. Allow the system to cool down for long enough that the error message is no longer displayed. It is also possible to continue riding without battery support, which aids the system's cooling process
BCOLD	The battery is too cold	Allow the system to warm up at room temperature for long enough that the error message is no longer displayed
BFAIL	Battery damaged	Please contact your Authorized Specialized Dealer immediately
ALERT	Battery is in protection mode	Restart the system. If the error continues to be displayed, contact an Authorized Specialized Dealer
SHORT	Short-circuit	Please contact your Authorized Specialized Dealer immediately
BUS F	Battery management is not communicating with the components	Restart the system. Check the connections
LO BA	Low battery	Connect the battery to the charger and plug into a power source to charge the battery
M-HOT	Motor overheating	Please pull over and turn off the system. Allow the system to cool down for long enough that the error message is no longer displayed. It is also possible to continue riding without battery support, which aids the system's cooling process. Do not touch the motor! Danger of burns!
M WRM	Motor very warm; danger of overheating	Reduce speed. Only ride in eco mode. Do not touch the motor! Danger of burns!
M ERR	Motor damaged	Please contact your Authorized Specialized Dealer
R ERR	Remote damaged	Please contact your Authorized Specialized Dealer

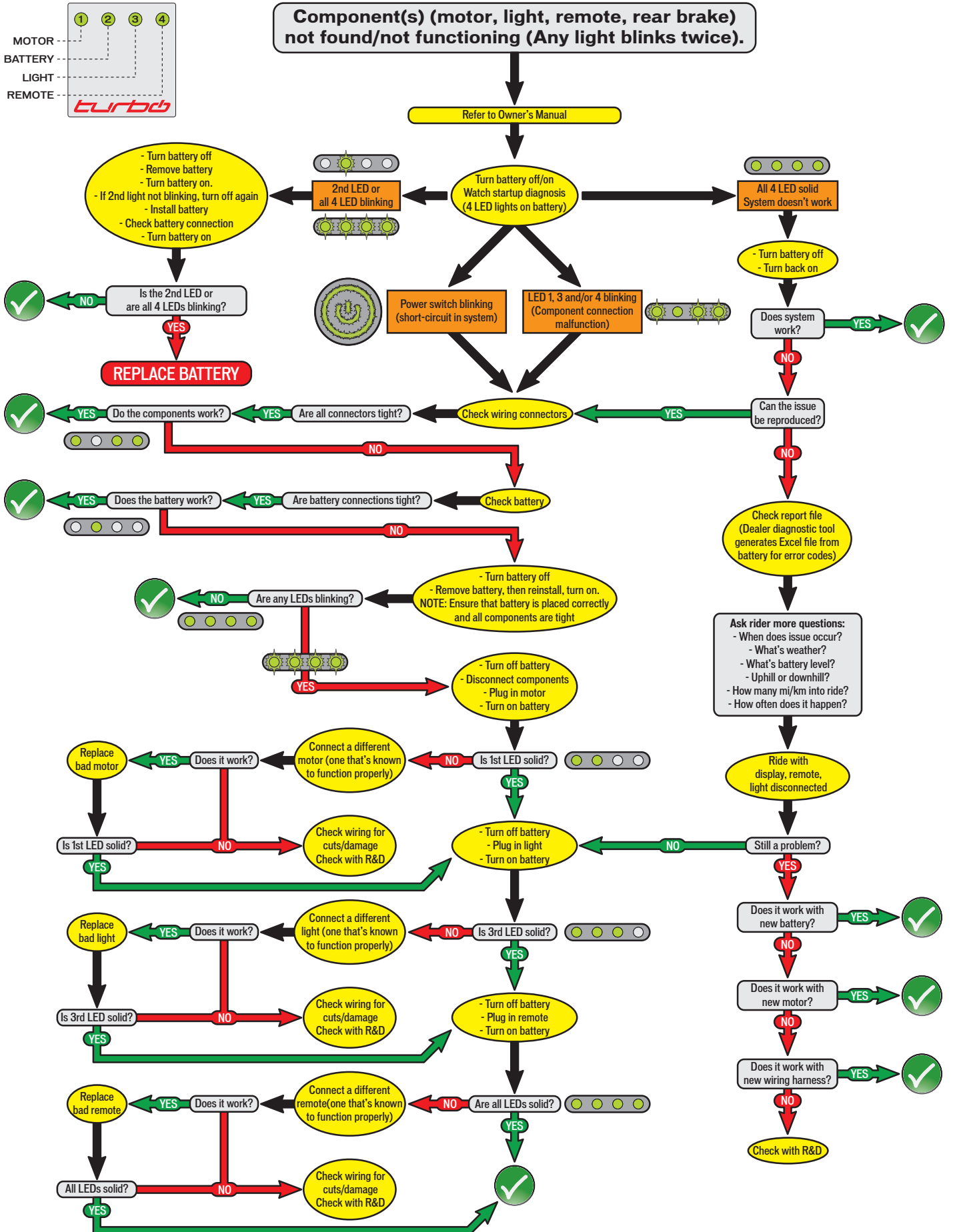

Please only allow an Authorized Specialized Dealer to carry out all checks and repairs. If the error continues to be displayed despite attempted solutions, contact an Authorized Specialized Dealer.

12. TURBO DIAGNOSIS DECISION TREE



13. LIGHTS

The lights only work when the battery is switched on (the background lighting of the screen is connected to this signal).

-  If the charge level of the bicycle's battery is 3% or less after a long ride, the drive system will switch itself off. At this point, the lights will work for approximately another 2 hours. If you switch off motor support, or the battery is empty, the lights are also switched off. In order to ride with lights again, you have to switch the lights back on using one of the switches.
-  Even if you want to ride without electrical support, you always have to carry a sufficiently charged battery with you. This is obligatory in order to be able to ride with lights if required.
-  When removing/installing the seatpost, be sure to unplug/plug the two wires that connect the backlight to the electrical system. There is no order or polarity to the two wires. Specialized recommends applying a piece of tape to the wires to stick the wires to the seat tube when the wires are disconnected, to avoid the possibility of the wires falling into the seat tube and out of reach.

14. NOTES ON ELECTRICAL AND ELECTRONIC COMPONENTS

 **WARNING!** The electrical motor in your bicycle is very powerful. To operate it correctly and safely, we recommend having it serviced by an Authorized Specialized Dealer on a regular basis. Immediately remove the battery if you identify any damage to the electrical system or see live parts exposed after a fall or accident. Always consult an Authorized Specialized Dealer if you require repairs, want to ask about a question or problem, or have identified a defect. Having a lack of Specialized authorized knowledge can result in serious accidents.

Before you carry out any repairs or care and maintenance work, always remove the battery first. Otherwise there is a danger of electrocution and injury.

15. MAINTENANCE AND CARE

- Servicing and cleaning work on live parts should only be undertaken by an Authorized Specialized Dealer.
- Only replace parts of your bicycle with original parts or those approved by Specialized. This could otherwise nullify any guarantee and warranty claims.
- When you clean the battery, ensure that you do not touch the contacts or connect them accidentally. If these contacts are live, the battery can be damaged, and may lead to injury.
- Cleaning your bicycle with a high pressure cleaner can damage the electrical systems. The high pressure can force cleaning fluid into sealed parts and damage them as a result.
- Avoid damaging cables and electrical components. If this happens, you should not ride the bicycle until it has been checked over by an Authorized Specialized Dealer.
- Before you carry out any repairs or care and maintenance work, always remove the battery first. Otherwise there is a danger of electrocution and injury.
- The rubber cap needs to be installed on the battery's charge port during transport

 **WARNING!** Lacking proper knowledge about your Specialized bicycle may result in misuse and /or serious accidents and/or injury.

16. DEALING WITH A FLAT TIRE / REMOVING A WHEEL

i Changing a flat tire is similar to a standard bicycle. Please read below for steps on how to remove and reinstall the rear wheel. If you are not familiar with how to repair a flat tire, please refer to your Authorized Specialized Dealer.

! Before you carry out any repairs or care and maintenance work, always remove the battery first. Otherwise there is a danger of electrocution and injury.

! Never remove or connect the plug when the system is switched on. Make sure battery is turned off before removal.

In order to replace a damaged tube if you have a flat tire, you have to remove the affected wheel (fig.15). If the rear wheel has to be removed, you first have to open the plug on the left rear dropout. To do this, you have to lift the locking tab of the plug. A flat object is well-suited to doing this, e.g. a screwdriver or key. Then pull both parts of the plug apart.

To remove the rear wheel axle, a 5mm Allen hex key is required. By turning counterclockwise, you can unscrew the axle and remove it.

Now you are able to remove the wheel from the frame or fork and change or patch the tube.

Reinstalling the wheel is the same process as removing the wheel, simply in reverse.

! **WARNING!** When installing the rear wheel, you have to guide the fitting element for the torque support back into the corresponding slot in the left dropout. Incorrectly placing this fitting element can lead to falls and serious injuries.

First rotate the fitting element (fig.16) into the correct position, as it can only be correctly inserted into its location in the frame in this way.

! **WARNING!** The disc brake rotor has to be correctly positioned between the brake pads when reinstalling the wheel. Incorrectly placing the disc brake rotor can lead to falls and serious injuries.

in-lbf
N*m

The axles have to be installed with the correct amount of torque (page 23).

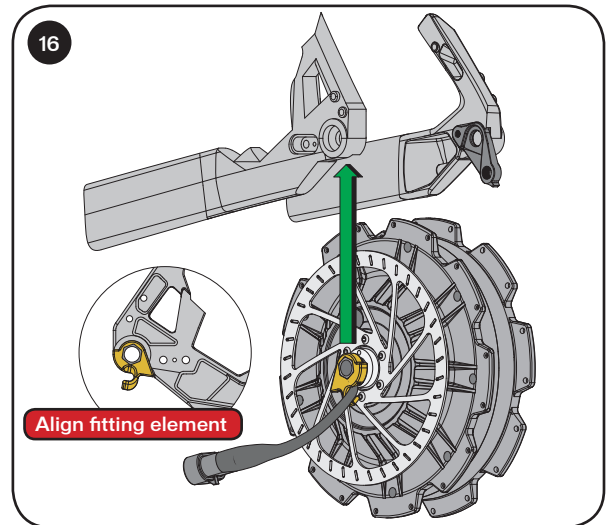
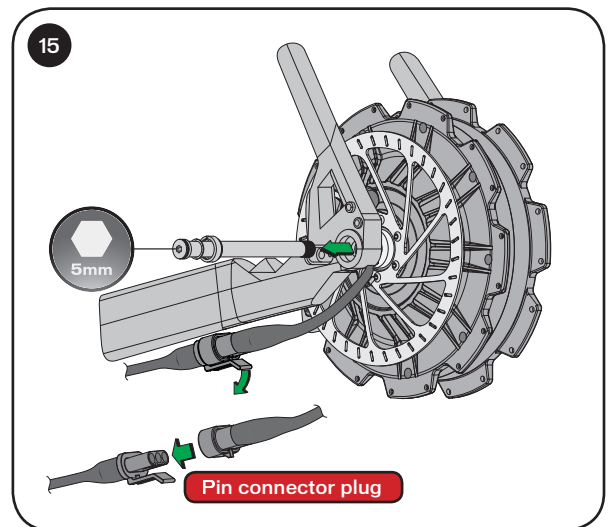

17. SERVICE PLAN

i Modern technology is highly efficient but also sensitive. You should service your bicycle on a regular basis. This requires Specialized authorized knowledge and tools. Allow your Authorized Specialized Dealer to do this type of work on your bicycle. You can get more information about your bicycle's parts as well as cleaning and maintenance in the instruction manual provided by your manufacturer or on the manufacturer's website.

To ensure that your bicycle remains in a safe condition and fulfils the conditions of the warranty, the following terms apply:

- Clean your bicycle after every ride and check it for possible damage.
- Allow your Authorized Specialized Dealer to carry out inspections.
- Check your bicycle every 300-500 kilometers (180-300 miles) or every three to six months (please refer to the dealer service schedule, page 27).
- Check that all screws and nuts are secure.
- Use a torque spanner to tighten screw joints.
- Clean and grease moving parts (excluding brake surfaces) according to instructions from the manufacturer.
- Allow your Authorized Specialized Dealer to touch up any paint damage.
- Ask your Authorized Specialized Dealer to replace any broken and worn parts.

! The first inspection is particularly important for ensuring that your bicycle remains safe and problem-free. Cables and spokes stretch, while bolted connections can loosen. Therefore always allow your Authorized Specialized Dealer to carry out the first inspection.

18. LUBRICATION

 Ask your Authorized Specialized Dealer for suitable lubricants. Not all lubricants are designed for all purposes. Using the wrong lubricants can lead to damage and impact the part's performance.

 **WARNING!** Working on the bicycle requires expert knowledge, experience and Specialized authorized tools. Only allow Authorized Specialized Dealers to work or check key parts on the bicycle.

19. WARNING NOTICES

- Please note that the parts of a electric bicycle are subject to higher levels of wear than a bicycle without an additional integrated motor. This is due to the heavier weight of the electric bicycle and higher average speed from the motor. This increased wear is not a material defect and is not covered by the warranty. Typically this affects the following parts:
 - Tires
 - Brake pads
 - Motor: Chain, cassette and chain rings
 - Spokes
 - The battery is subject to aging and is therefore also a wearable part. Please note that the battery gradually loses its capacity depending on its age and operating life. Take this into account when planning journeys and ensure that you switch to a new battery in good time. Replacement batteries can be purchased from your Authorized Specialized Dealer.
 - Electrical devices (electric bicycle or individual parts such as the battery or charger) are not suitable for use by children under the age of 12.
- It is possible to achieve substantially higher speeds on the Turbo than with a normal bicycle, due to the support provided by the electric bicycle's motor. This might feel very unusual. Therefore it is important to practice riding the electric bicycle to get used to it.
- During long rides on steep gradients, the electric bicycle's motor can heat up, creating a risk of burn. Therefore avoid coming into contact with the motor with your hands, feet or legs.
- When assembling the rear brake disc, only use original screws or screws with the specification M5 x7mm. Incorrect screw lengths can lead to accidents or serious falls, or block the motor internally.
- The electric bicycle works with low voltage (36V). Only use suitable original batteries for operating the electric bicycle. Never use other voltage sources.
- Live parts can be exposed when opening the covers or exchanging components. Connection pieces could also be live. Therefore, servicing work or repairs on a live open device should only be carried out by your Authorized Specialized Dealer.
- When setting up, servicing or cleaning the electric bicycle, the cables should neither be substantially compressed or damaged by sharp edges.
- If live components or the battery have suffered visible damage, the electric bicycle can no longer be used without possible danger to you. If it is no longer possible to use the bicycle safely, refrain from using your electric bicycle. Please ensure that the electric bicycle cannot be used by any third persons without your consent. Please only ride your electric bicycle again when your Authorized Specialized Dealer has checked your electric bicycle.
- Electrical devices are not suitable for use by children. Do not leave children unattended with the bicycle.
- Li-Ion batteries are subject to special conditions during transport. For more information about transporting the product, please contact your Authorized Specialized Dealer.

EUROPE: WARRANTY AND LIABILITY IN THE CASE OF DEFECTS

 In all nations covered by EU law, the common conditions for warranty/liability for material defects apply. Please inform yourself about the applicable national regulations in your specific country.

Under EU law, the seller accepts liability for material defects for at least two years after the date of sale. This also covers defects which already existed at the time of sale/change of ownership. In fact, if material defects occur within the first six months, the assumption is made that these already existed at the time of sale.

One precondition for the seller assuming this liability is that the product's use and maintenance was in line with all conditions stipulated. These are outlined in the pages of this instruction manual and in the supplied instructions from the component manufacturers.

In Germany/Austria, the customer can first request subsequent fulfilment (repair). If repair fails conclusively, which is the assumption after two attempts, the customer is entitled to abatement or cancellation of the contract. In Switzerland, liability is limited to one year after the date of sale. When a defect occurs, you have the choice between rescission, abatement and subsequent delivery or rework.

When a defect occurs, you have the choice between rescission, abatement and subsequent delivery or rework.

Liability for material defects does not cover normal wear occurring from the product's intended purpose. Components in the motor and deceleration system as well as tires, light system and contact points of the rider with the LTe S-Pedelec/Pedelec are all subject to use-related wear, as is the battery.

If Specialized provides other additional guarantees, these are listed at www.specialized.com, or ask your Authorized Specialized Dealer. Please consult the respective warranty terms for more information on the conditions of these and of any possible claims under these.

 In the case of a defect/possible liability claim, please contact your Authorized Specialized Dealer. We recommend filing all purchase receipts and inspection reports as proof for your records.

20. TORQUE SPECS

PRODUCT DESCRIPTION	TORQUE SPEC	PRODUCT DESCRIPTION	TORQUE SPEC
Stem @ steerer tube	45 in-lbf (5.1 Nm)	Rear derailleur	70-88 in-lbf (8-10 Nm)
Stem @ handlebar	45 in-lbf (5.1 Nm)	Rear wheel axle	133 in-lbf (15 Nm)
Seat collar	55 in-lbf (6.2 Nm)	Shifter	25-30 in-lbf (2.8-3.4 Nm)
Seatpost @ saddle rails	120 in-lbf (13.5 Nm)	Head light	26-45 in-lbf (3-5 Nm)
Bottom bracket	355-445 in-lbf (40-50 Nm)	License plate/reflector mount	45 in-lbf (5.1 Nm)
Crank bolts	336-363 in-lbf (38-41 Nm)	Water bottle bolts	35 in-lbf (4 Nm)
Chainring bolts	104 in-lbf (12 Nm)	Kick stand bolt	89 in-lbf (10 Nm)
Disc brake caliper bolts	80 in-lbf (9 Nm)	Fender bolts	35 in-lbf (4 Nm)
Disc brake rotor bolts	40 in-lbf (4.5 Nm)	Fender stay bolts	35 in-lbf (4 Nm)
Brake levers	22 in-lbf (2.5 Nm)		

21. TECHNICAL INFORMATION

WEIGHT	Weight of Specialized Turbo: 49.1 lb (22.3 kg)	BATTERY	Capacity 13 Ah / 468Wh
	Maximum permitted weight: 295 lb (134 kg)		36V
MOTOR	Nominal capacity: 200 Watt		Weight 8.0 lb (3.6 kg)

22. LEGAL REGULATIONS FOR S-PEDELEC ONLY (2002/24/EC)

A. Use on public roads

Before riding your bicycle on public roads, you should inform yourself about the applicable national regulations in your specific country. In Germany, the applicable laws are the StVZO (German Motor Vehicles Regulation) and the STVO (German Road traffic act).

Pedelecs fall under the jurisdiction of the same EU laws as a normal bicycle. Pedelecs are also subject to the same laws as bicycles when using cycle tracks.

Turbo bicycles are either as a Speed Pedelec in the L1e class with support up to a maximum of 45 km/h (28 mph), or as a bicycle with support up to a maximum of 25 km/h (15.5 mph). On request, the bicycle support can be increased to 45 km/h (28 mph) or decreased to 25 km/h (15.5 pmh) by your Authorized Specialized Dealer.

DE Germany: The StVZO requires (current version from August 2013, currently under review):

- A light system with a white front light and a red rear light
- Lights powered by a fixed dynamo (6V, 3W) or battery (6V)
- A clearly audible bell
- Reflectors:
 - Front: White, large, can be integrated into the light
 - Rear: Two red, one can be integrated into the rear light
 - Wheels: Two yellow reflectors per wheel, alternatively white reflective rings in the tire, rims or spokes
 - Pedals: One yellow reflector pointing forward and backward per pedal

i If your Pedelec does not have a dynamo, you will also have to carry the sufficiently loaded battery of your Pedelec along with you whenever you ride without electrical support, or 6V-powered battery light.

i When the battery charge drops below 3%, the Pedelec switches the motor off, which means that it can still provide at least two hours of lighting.

Every system has to have the stamp of official authorisation: A German "Wellenlinie" and "K" number.

When making technical changes to the components on your L1e S-Pedelec, please note that electrical parts may only be replaced with type-tested components.

A Austria: Participating in public road traffic in Austria requires riders to comply with Act 146 / "the Bicycle Act" (Fahrradverordnung). This is outlined in the Austrian Federal Law Gazette (Bundesgesetzblatt).

CH Switzerland: In Switzerland, the applicable regulations are outlined in the guidelines for the technical requirements of road traffic in articles 213 to 218 (Verordnungen über die technischen Anforderungen an Strassenfahrzeuge).

B. Other legal regulations

i Please inform yourself about the applicable national regulations in your specific country.

DE Germany:

- The motor is allowed to support the rider when he or she is actually turning the pedals. The central motor capacity is capped at 250 W and the support has to switch off at 25 km/h.
- The rider is not legally obligated to wear a helmet or hold a driver's licence or insurance, and there is also no minimum age requirement.

Making helmets compulsory is currently being discussed, please inform yourself about the applicable regulations before using your bicycle. However, we strongly recommend wearing a suitable bicycle helmet.

If you were born after 1.4.1965, you require a moped license which is also included in every normal German driver's license.

A Austria : In Austria, an electrically powered bicycle which can achieve a maximum speed of 25 km/h by itself and which has a motor with a maximum capacity of 600 W is classified as a bicycle and is therefore subject to the equipment regulations stipulated in "the Bicycle Act" (Fahrradverordnung). As is the case with normal (leg-powered) bicycles, riding this type of bicycle is subject to the relevant StVO regulations, including the usual obligation to use cycle paths.

CH Switzerland: If the electric bicycle is a Pedelec (<25 km/h), the rider is not required to wear a helmet and is not subject to any speed limits, as the speed from the motor and rider can be added together.

In Switzerland, electric bicycles which can exceed the speed of 25 km/h (L1e S-Pedelecs / Motorfahrrad / Cyclomoteur) require a driver's licence, number plate, proof of insurance, and as of July, 2012, require the use of a bicycle helmet. L1e S-Pedelecs have to be insured as a low-performance moped.

i Any changes to the L1e S-Pedelec/Pedelec not approved by Specialized, which could lead to a change in the motor performance and/or the possible top speed, have the following effects:

- nullifying the warranty requirements on the manufacturer's side
- possible changes to the insurance obligations
- possible changes to the drivers' license obligations



23. THE DIFFERENCE BETWEEN THE L1e S-PEDELEC AND PEDELEC

The L1e S-Pedelec/ bicycle is delivered as a speed Pedelec in the class L1e with support up to a maximum of 45 km/h. The class L1e counts as a lightweight motorcycle according to guideline 2002/24/EG. On request, the bicycle support can be reduced to 25 km/h by your Authorized Specialized Dealer, which would lead to classification as a Pedelec under EN 15194 and therefore as a bicycle.

A. Regulations for L1e S-Pedelecs

i If your bicycle supports speeds faster than 25 km/h, it is not a Pedelec pursuant to guideline 2002/24/EG, and it therefore requires type and individual vehicle approval.

The national regulations are as follows:

DE Germany:

- Speed Pedelecs are legally categorized as mopeds in class L1e.
- On journeys using motor support only (using speed switch, no pedaling), you are not permitted to ride over 20 km/h.
- Using pedal-assist, the motor support switches off when you reach approximately 45 km/h.
- Making helmets compulsory is currently being discussed, please inform yourself about the applicable regulations before using your bicycle. However, we strongly recommend wearing a suitable bicycle helmet.
- Riding this type of Pedelec requires a driver's license. The legal requirement is for a moped license. If you have a German driver's license, the latter is included in this.
- If you were born before 1.4.1965, you are permitted to drive a L1e S-Pedelec without a driver's license.
- You are obligated to have insurance.

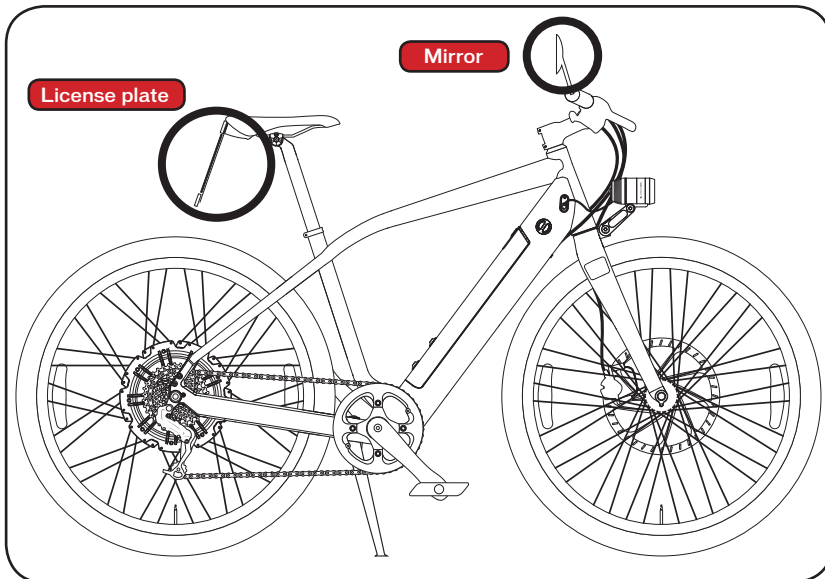

These regulations also apply to you if you are within the scope of the European Union. Differing regulations may apply in other countries, including other European nations in isolated cases. Please inform yourself about the applicable legislation before using your L1e S-Pedelec.

B. L1e S-Pedelecs and cycle paths

If you use your L1e S-Pedelec like you would a normal bicycle, without the support of the electric motor, you are permitted to use all cycle paths without limitation. The following applies if you use the motor:

- L1e S-Pedelec bicycles are only permitted to use cycle paths if motor vehicles are allowed.

i Please inform yourself about the applicable national regulations in your specific country.

Speed switch

The L1e S-Pedelec also has a speed switch. Your L1e S-Pedelec is not designed to exceed 20 km/h if you press the joystick up or down and do not turn the pedals. That is why you have to inform yourself about the applicable regulations before using this vehicle.

! **WARNING!** The additional force from the motor could mean that you travel at a considerably higher speed than you are used to on your bicycle. Please take this into account when familiarizing yourself with the L1e S-Pedelec.

C. Intended use

! **WARNING!** L1e S-Pedelecs/Pedelecs are intended for transporting one person at a time. If you are planning to transport additional people, then the regulations of the StVO apply in Germany. An exception to this is the tandem, for instance. If you would like to transport luggage, this requires that your bicycle is fitted with suitable equipment. Children can only be transported in children's seats or trailers intended for this purpose on the Pedelecs at a maximum support speed of 25 km/h. We recommend not taking any chances when it comes to quality in this area. Vehicles in the class L1e are not permitted to use a child's seat or trailer. A cargo trailer is allowed for both Pedelecs and L1e S-Pedelecs.

Ensure that you do not exceed the maximum permissible weight of 134 kg (see [page 23](#)).

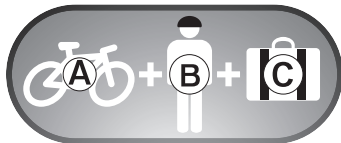

Permitted weight: Bicycle weight (A) + Rider's weight (B) + Baggage weight (excluding trailers) (C).

Using the bicycle as intended also means adhering to the operating, maintenance and upkeep conditions described in this manual. If your bicycle is equipped in line with national law, the bicycle may be used on public roads and on paved surfaces.

Your bicycle has been approved by the manufacturer for installing a child seat and trailer. Please inform yourself about the applicable national regulations in your specific country relating to the use of a child seat or trailer. Trailers in particular are not allowed in every country.

! **WARNING!** Do not allow children to use the bicycle unattended and without detailed instruction! Ensure that children understand the dangers of using electrical devices. Please refer to your country's regulations for minimum age requirements.

The manufacturer and dealer do not assume any liability for activities above and beyond the intended use. This particularly applies for not adhering to safety advice and damage resulting from this, for instance: off-road use, carrying excess weight or making improper repairs to defects.

The bicycle is not generally designed to withstand extreme stress, such as riding down steps or over jumps.

24. REPLACING PARTS ON YOUR L1e S-PEDELEC

Specific components are defined in the approvals process which are allowed to be used on this bicycle. In other words, the L1e S-Pedelec is only legal if it uses these parts or replacement parts which have been approved for use with your model.

If parts are subsequently changed or replaced, please only use original parts or replacements which are approved for use on your L1e S-Pedelec, otherwise you must seek individual permission from the TÜV or your local regulatory authority.

A. Parts which may be replaced like-for-like or with approved parts are as follows:

• Frame	• Battery	• Brake system	• Number plate holder	• Stem
• Fork	• Tires	• Front light	• Kickstand	
• Motor unit	• Rims	• Rear light	• Handlebar	

Replacement tires

Model	Standard Size	ETRTO Size	Max. Load (kg)
Specialized Borough XC Sport	45-622	700x45	80
Specialized Borough Sport	45-622	700x45	80
Specialized Borough Armadillo	45-622	700x45	80
Specialized Crossroads Armadillo / Elite	38-622	700x38	80
Specialized Crossroads	38-622	700x38	80
Specialized Hemisphere Armadillo	38-622	700x38	80
Specialized Hemisphere Armadillo	42-622	700x42	80
Specialized Hemisphere Sport	38-622	700x38	80
Specialized Hemisphere Sport	42-622	700x42	80
Specialized Infinity	38-622	700x38	80
Specialized Infinity	42-622	700x42	80
Specialized Infinity	47-622	700x47	80
Specialized Infinity Armadillo	38-622	700x38	80
Specialized Infinity Armadillo	42-622	700x42	80
Specialized Infinity Armadillo	47-622	700x47	80
Specialized Infinity Sport	38-622	700x38	80
Specialized Infinity Sport	42-622	700x42	80
Specialized Infinity Sport	47-622	700x47	80
Specialized Nimbus Armadillo / Elite	38-622	700x38	80
Specialized Nimbus Sport	38-622	700x38	80
Specialized Trigger	47-622	700x47	80
Specialized Trigger Sport	38-622	700x38	80
Specialized Trigger Sport	42-622	700x42	80
Specialized Trigger Sport	47-622	700x47	80

Model	Standard Size	ETRTO Size	Max. Load (kg)
Schwalbe Energizer Pro	37-622	700x35	95
Schwalbe Energizer Pro	40-622	700x38	100
Schwalbe Energizer Pro	47-622	700x47	115
Schwalbe Energizer Plus	37-622	700x35	95
Schwalbe Energizer Plus	40-622	700x38	100
Schwalbe Energizer Plus	47-622	700x47	115
Schwalbe Energizer Plus Tour	37-622	700x35	95
Schwalbe Energizer Plus Tour	40-622	700x38	100
Schwalbe Energizer Plus Tour	47-622	700x47	115
Schwalbe Marathon	37-622	700x35	95
Schwalbe Marathon	40-622	700x38	100
Schwalbe Marathon	47-622	700x47	115
Schwalbe Marathon Deluxe	37-622	700x35	95
Schwalbe Marathon Deluxe	40-622	700x38	100
Schwalbe Marathon Plus	37-622	700x35	95
Schwalbe Marathon Plus	40-622	700x38	100
Schwalbe Marathon Plus	47-622	700x47	115

25. DEALER SERVICE SCHEDULE

<p>1st Inspection: After approx. 200 kilometers (120 miles)</p> <p>Work done:</p> <hr/> <hr/> <hr/> <hr/> <hr/> <hr/> <hr/> <hr/> <hr/> <hr/>	<p>2nd Inspection: After approx. 1000 kilometers (600 miles)</p> <p>Work done:</p> <hr/> <hr/> <hr/> <hr/> <hr/> <hr/> <hr/> <hr/> <hr/> <hr/>	<p>3rd Inspection: After approx. 2000 kilometers (1200 miles)</p> <p>Work done:</p> <hr/> <hr/> <hr/> <hr/> <hr/> <hr/> <hr/> <hr/> <hr/> <hr/>
<p>Materials used:</p> <hr/> <hr/> <hr/> <hr/> <hr/> <hr/>	<p>Materials used:</p> <hr/> <hr/> <hr/> <hr/> <hr/> <hr/>	<p>Materials used:</p> <hr/> <hr/> <hr/> <hr/> <hr/> <hr/>
<p>Date: _____</p> <p>Signature: _____</p> <p>Dealer Stamp:</p>	<p>Date: _____</p> <p>Signature: _____</p> <p>Dealer Stamp:</p>	<p>Date: _____</p> <p>Signature: _____</p> <p>Dealer Stamp:</p>
<p>4th Inspection:</p> <p>Work done:</p> <hr/> <hr/> <hr/> <hr/> <hr/> <hr/> <hr/> <hr/> <hr/> <hr/>	<p>5th Inspection:</p> <p>Work done:</p> <hr/> <hr/> <hr/> <hr/> <hr/> <hr/> <hr/> <hr/> <hr/> <hr/>	<p>6th Inspection:</p> <p>Work done:</p> <hr/> <hr/> <hr/> <hr/> <hr/> <hr/> <hr/> <hr/> <hr/> <hr/>
<p>Materials used:</p> <hr/> <hr/> <hr/> <hr/> <hr/> <hr/>	<p>Materials used:</p> <hr/> <hr/> <hr/> <hr/> <hr/> <hr/>	<p>Materials used:</p> <hr/> <hr/> <hr/> <hr/> <hr/> <hr/>
<p>Date: _____</p> <p>Signature: _____</p> <p>Dealer Stamp:</p>	<p>Date: _____</p> <p>Signature: _____</p> <p>Dealer Stamp:</p>	<p>Date: _____</p> <p>Signature: _____</p> <p>Dealer Stamp:</p>

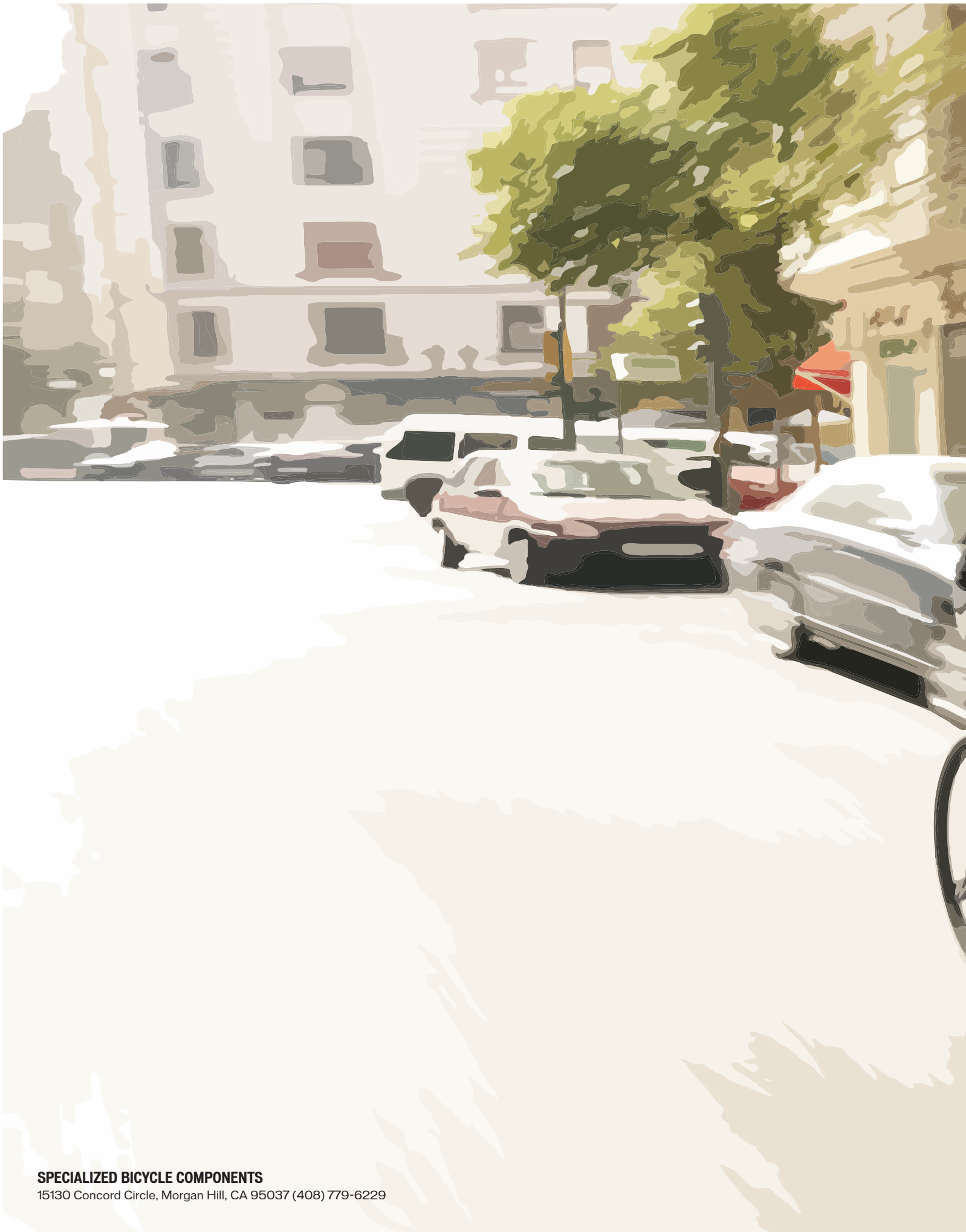

SPECIALIZED BICYCLE COMPONENTS

15130 Concord Circle, Morgan Hill, CA 95037 (408) 779-6229